

FUNCTION MANUAL, INSTALLATION

GOLD RX/PX/CX/SD Generation F

Applicable to Program Version 1.31 and newer versions

Content

1. Image Management	3		
2. Main Setup	4		
3. Filter Calibration	4		
4. Functions	5		
4.1 Airflow.....	5	4.12 Cool.....	40
4.1.1 Status.....	5	4.12.1 Status.....	40
4.1.2 Operation level.....	5	4.12.2 Extra regulation sequences 1 and 2.....	40
4.1.3 Regulation mode.....	6	4.12.3 Extra regulation sequences 1 and 2, combi coils.....	41
4.1.4 Optimize.....	7	4.12.4 Cool.....	42
4.1.5 Set point displacement.....	7	4.12.5 Xzone.....	43
4.1.6 Unit.....	7	4.12.6 COOL DX.....	43
4.1.7 Air adjustment.....	7	4.12.7 Delay time.....	44
4.1.8 Outdoor air compensation.....	8	4.12.8 Outdoor air limits.....	44
4.1.9 Booster diffusers.....	9	4.12.9 Airflow, limits.....	45
4.1.10 Automatic operation.....	9	4.13 Heat/Cool recovery.....	46
4.2 Temperature.....	10	4.13.1 Status.....	46
4.2.1 Status.....	10	4.13.2 Carry over control.....	46
4.2.2 Settings.....	10	4.13.3 Efficiency measurement.....	46
4.2.3 Regulation mode.....	13	4.13.4 Defrost.....	47
4.2.4 Unit of temperature.....	14	4.13.5 Calibration/Optimization (GOLD PX).....	48
4.2.5 Set point displacement.....	14	4.13.6 Automatic functions.....	48
4.2.6 Night compensation.....	14	4.14 HC, reversible heat pump/chiller.....	49
4.2.7 Neutral zone.....	15	4.15 SMART Link.....	50
4.2.8 External temperature sensors.....	15	4.16 Humidity.....	51
4.2.9 Regulation sequence.....	16	4.16.1 Status.....	51
4.2.10 Min. exhaust air.....	17	4.16.2 Humidifying.....	51
4.2.11 Morning Boost.....	18	4.16.3 Dehumidifying.....	52
4.2.12 Heating Boost.....	18	4.16.4 Humidifier alarm.....	52
4.2.13 Cooling Boost.....	19	4.17 ReCO ₂	53
4.2.14 Intermittent night heat.....	20	4.18 All Year Comfort.....	54
4.2.15 Summer night cool.....	21	4.19 MIRU.....	55
4.2.16 Down regulation (airflow/pressure).....	22	4.20 Inputs/Outputs.....	57
4.3 Time and schedule.....	23	4.21 Communication.....	58
4.3.1 Time and date.....	23	4.21.1 External Port B.....	58
4.3.2 Schedule settings.....	23	4.21.2 Wireless LAN.....	58
4.3.3 Day schedule.....	24	4.21.3 E-mail.....	59
4.3.4 Exceptions schedule.....	24	4.21.4 EIA-485.....	59
4.3.5 Calendar 1 and 2.....	25	4.21.5 Modbus TCP.....	59
4.3.6 Prolonged operation.....	25	4.21.6 BACnet IP.....	59
4.4 Energy monitoring.....	26	4.21.7 EXOline TCP.....	60
4.5 Filters.....	26	4.21.8 Operation level communication.....	60
4.6 Software.....	26	4.22 Base setting.....	61
4.7 Language.....	26	4.23 Users.....	61
4.8 Alarm settings.....	27	4.24 Notes.....	62
4.8.1 Fire alarms.....	27	4.25 Manual test.....	62
4.8.2 External alarms.....	28	4.26 IQnavigator (hand-held terminal).....	63
4.8.3 Temperature protection.....	28	4.26.1 Connect to IQlogic.....	63
4.8.4 Temperature alarm limits.....	29	4.26.2 Backlight brightness.....	63
4.8.5 Service period.....	29	4.26.3 Acoustics.....	63
4.8.6 Alarm priority.....	30		
4.9 Log.....	31		
4.9.1 Continuous log.....	31		
4.9.2 Log sender.....	31		
4.10 Air handling unit.....	32		
4.10.1 Settings.....	32		
4.10.2 Fan status.....	33		
4.10.3 Operation time.....	33		
4.10.4 VOC/CO ₂ sensor.....	33		
4.10.5 Automatic functions.....	34		
4.11 Heat.....	35		
4.11.1 Status.....	35		
4.11.2 Pre-heat.....	35		
4.11.3 Extra regulation sequences 1 and 2.....	36		
4.11.4 Extra regulation sequences 1 and 2, combi coils.....	37		
4.11.5 Reheat.....	38		
4.11.6 Xzone.....	38		
4.11.7 Electric air heater.....	39		
4.11.8 Season Heat.....	39		
4.11.9 Automatic functions.....	39		

The document was originally written in Swedish.

1. Image Management

If the touch screen is at rest, press the hand-held terminal's On/Off button.



Profile selection. Press on installation. Kod=1111.



Main setup. See Section 2.

Filter calibration. See Section 3.

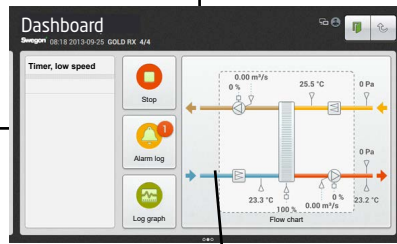

Dashboard. See Section 2.2 in the Operating Procedures Manual of the IQnavigator hand-held micro terminal.

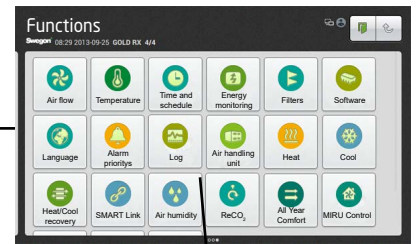

Functions. See Section 4

2. Main Setup

Main setup can be selected when installing the AHU and is an aid for configuring and starting up the AHU.

Time and date, air flow unit, airflow regulation mode, airflow operation level, temperature regulation, temperature settings and fan position settings can be entered here.

For more detailed information, see the relevant function below.

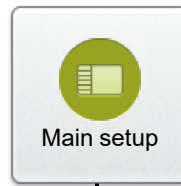

- See Section 4.3.1
- See Sections 4.1.6 and 4.2.4
- See Section 4.1.3
- See Section 4.1.2
- See Section 4.2.3.
- See Section 4.2.2.
- See Section 4.10.1

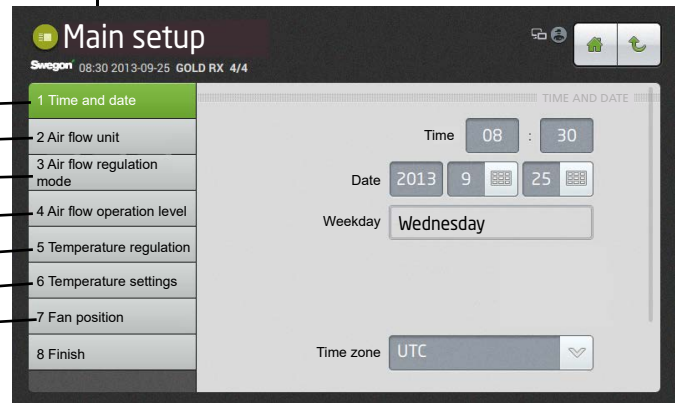

3. Filter Calibration

All the filters should be calibrated when the fans are started up for the first time and when the duct system, air terminals and commissioning plates, if required, have been installed and commissioned.

After that every time filters are replaced. Calibration should then be activated for the filter or filters that are new. Relevant filters are the Supply air prefilter, Extract air pre-filter, Supply air AHU filter, Extract air AHU filter, SA and EA AHU filter and Supply air end filter.

When filter calibration is activated, the air handling unit runs at the preset max. speed (depending on the functionality selected) for about 70 seconds.

After the filters have been calibrated, a pressure rise of up to 100 Pa is permissible (as the filters arrest impurities) after which an alarm indicating fouled filter is initiated. The alarm limit can be changed under Installation, Functions, Filters.

The filter function must be activated (see Section 4.5) in order to make it possible to enable filter calibration and alarm functions of the end filter and pre-filter in GOLD SD supply air and extract air handling units.

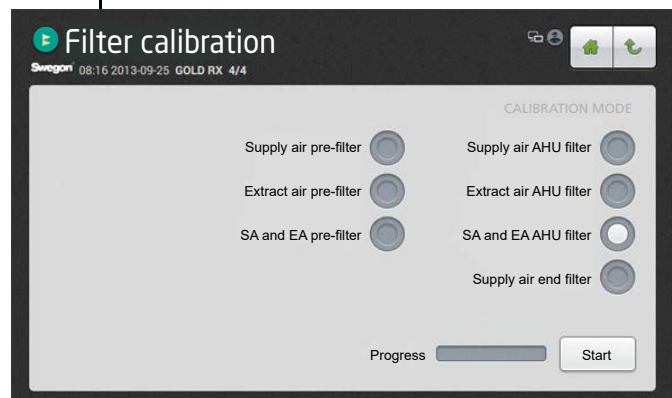
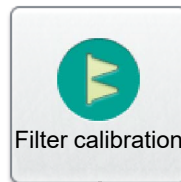

4. Functions

4.1 Airflow

4.1.1 Status

All the relevant values can be read here. Used for performance checks.

4.1.2 Operation level

The functions selected and the min. and max. airflows of each AHU size (see the table below) determine which values can be set.

Depending on the function selected, flows can be set as follows (l/s, m³/s, m³/h, cfm), pressure (Pa, psi, in.wc) or input signal strength (%).

Low speed

Should always be preset. The value for low speed cannot be higher than the value for high speed. Low speed can be set to 0, which means that the AHU is idle.

High Speed

Should always be preset. The value or pressure for high speed cannot be lower than the value for low speed.

Max. speed

Should always be preset. Used mainly for filter calibration. While filter calibration is in progress, the max. speed setting should be as high as the ventilation system permits without causing any breakdown. Also used for the pressure regulation, boosting, Heating Boost and Cooling Boost functions. The value for max speed cannot be lower than the value for high speed.

Min./Max. flows

AIRFLOW SIZE	MIN. FLOW FOR AIRFLOW REG., ALL VARIANTS ²		MAX. FLOW, ONE-PIECE AHU ROTARY HEAT EXCH. (RX)		MAX. FLOW, ONE-PIECE AHU PLATE H. EXCH. (PX)		MAX. FLOW, ONE-PIECE AHU COIL H. EXCH. (CX)		MAX. FLOW, SA AND EA AHU'S (SD)	
	m ³ /h ¹	m ³ /s	m ³ /h	m ³ /s	m ³ /h	m ³ /s	m ³ /h	m ³ /s	m ³ /h	m ³ /s
GOLD 004	288	0,08	1620	0,45	1620	0,45			2160	0,6
GOLD 005	288	0,08	2340	0,65	2340	0,65			2880	0,8
GOLD 007	288	0,08	2700	0,75	2700	0,75			2880	0,8
GOLD 008	720	0,20	3600	1,00	3600	1,00			4320	1,2
GOLD 011	720	0,20	3960	1,10	3960	1,10			4320	1,2
GOLD 012	720	0,20	5040	1,40	5040	1,40			6480	1,8
GOLD 014	720	0,20	5940	1,65	5940	1,65			6480	1,8
GOLD 020	1080	0,30	7560	2,10	7560	2,10			10080	2,8
GOLD 025	1080	0,30	9000	2,50	9000	2,50			10080	2,8
GOLD 030	1800	0,50	11520	3,20	11520	3,20			14400	4,0
GOLD 035	1800	0,50	14040	3,90	14040	3,90	14040	3,90	14400	4,0
GOLD 040	2700	0,75	18000	5,00	18000	5,00	18000	5,00	21600	6,0
GOLD 050	2700	0,75	18000	5,00			18000	5,00	20160	5,6
GOLD 060	3600	1,00	23400	6,50			23400	6,50	28800	8,0
GOLD 070	3600	1,00	27000	7,50			27000	7,50	28800	8,0
GOLD 080	5400	1,50	34200	9,50			34200	9,50	43200	12,0
GOLD 100	5400	1,50	39600	11,0			39600	11,0	43200	12,0
GOLD 120	9000	2,50	50400	14,0			50400	14,0	64800	18,0

1) When adjusting the flow, round off the value to the nearest settable step.

2) If pressure regulation is used, the airflow can be regulated to zero, however this presupposes a certain static pressure drop in the ducting (approx. 50 Pa).

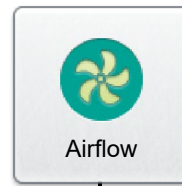

Status

Operation level

Min. /Max. speed

Used for the demand control function (the previous section also applies to max. speed). Preset the lowest and highest permissible flows for each fan. This means that the fans will not operate outside these limits, regardless the load.

Slave

The flow difference for any slave controlled fan can be set between the slave controlled fan and the other fan. The setting occurs in a fixed flow difference and/or a percentage difference.

4.1.3 Regulation mode

The regulation mode can be selected individually for the supply air or the extract air respectively.

Regulation mode

Airflow

Flow regulation involves operating the air handling unit to keep the preset airflow constant. The speed of the fans is automatically regulated to provide correct airflow even if the filters begin to become clogged, if air diffusers become blocked, etc.

A constant airflow is advantageous, since the airflow is always at the level preset from the beginning.

It should however be noted that everything that increases the pressure drop in the ventilation system, such as the blocking of air devices and dust accumulating in the filters, causes the fans to run at a higher speed. This causes higher power consumption and may also cause discomfort to the occupants such as excessive sound.

Duct pressure

The airflow automatically varies to provide constant pressure in the ducting. This type of regulation is therefore also called VAV Regulation (Variable Air Volume).

Pressure regulation is used when e.g. damper operations increase the air volume in sections of the ventilation system.

The duct pressure is measured by an external in-duct pressure sensor which is connected to the control unit's BUS communication. The set point required (separate for low speed and high speed) is preset in Pa.

The function can be limited so that the fan speed will not exceed the preset max. values.

Demand

The airflow required is regulated in response to 0-10 V input signals from an external sensor, such as a carbon dioxide sensor, connected to control unit terminals 18-19. The required set point is set as a percentage of the input signal or in ppm.

The function can be limited so that the flow will not be higher or lower than the preset max. and min. values respectively.

Slave

Normally the flow is constantly regulated to the same value as the other fan. If one fan is pressure-controlled or demand-controlled, the other one can be controlled as a slave to generate the same air flow.

The performance of the slave fan can be restricted if its maximum flow is set to a lower airflow rate.

It is also possible to set a flow difference between the slave controlled fan and the other fan. The setting occurs in a fixed flow difference and/or a percentage difference. For example, this can be used when there is a separate extract air fan and balanced ventilation is wanted.

It is not possible to control both fans as slaves. If you select one fan to operate as a slave, you lose the option to select the other fan as a slave.

Settings:

Value
Supply air

Extract air

Settings
Airflow
Duct pressure
Demand
Slave
Airflow
Duct pressure
Demand
Slave

4.1.4 Optimize

The Optimize function optimises the air handling unit's airflow for the connected WISE system; see separate documentation for the WISE.

The function requires that the duct pressure setting is preset regulation type.

Settings:

Value	Setting range	Factory setting
Optimize	On/Off	Off

Optimize

4.1.5 Set point displacement

The airflow is regulated between two flows in response to an 0-10 V DC input signal from an external signal, for example a potentiometer. The TBIQ-3-2 IQlogic+ module accessory is required.

Set point displacement can be used e.g. in assembly halls, where a higher rate of air change is needed under full-load conditions.

The function is activated only when the AHU fans operate at high speed.

On a 0-10 V DC signal, the fans are gradually accelerated from the AHU's high speed setting to its max. speed setting. On a max. input 10 V DC signal, the AHU fans operate at max. speed.

The function must be activated separately for the supply air fan and for the extract air fan.

Settings:

Value	Setting range	Factory setting
Supply air	On/Off	Off
Extract air	On/Off	Off

Set point displacement

4.1.6 Unit

The required unit of airflow and unit of pressure can be set.

Settings:

Value	Setting range	Factory settings
Unit of airflow	l/s m ³ /s m ³ /h cfm	m ³ /s
Unit of pressure	Pa psi in.wc	Pa

Unit

4.1.7 Air adjustment

The speed of the fans can be locked for up to 72 hours. When the function is activated, the speed is locked at the current speed of operation. This is practical when making airflow adjustments in the duct system and air terminals. The desired period is preset, but can be interrupted earlier by selecting Stop or by changing the time setting to 0.

Air adjustment

4.1.8 Outdoor air compensation

Outdoor air compensation of the airflow can be activated if you want to change the airflow for specific outdoor air temperatures. An individually adjusted curve regulates the ratio between the airflow and the outdoor air temperature. The curve has four adjustable breakpoints..

If the function is selected solely for low speed or high speed operation, the curve will regulate only one of these. The airflow for the operating case that has not been selected will then be according to the preset set point for airflow/duct pressure.

In the flow regulation mode, the current set point for airflow is changed. When pressure regulation is selected, the current set point for pressure is changed. The function has no effect if the airflow is demand-controlled.

The airflow change is expressed in the preset airflow unit and pressure in Pa.

Settings:

Value	Setting range	Factory setting
Outdoor air compensation mode	Inactive/Low speed/High speed/Low speed and High speed	Inactive
X1, breakpoint, outdoor air temp.	-50 – +50 °C	-20 °C
X2, breakpoint, outdoor air temp.	-50 – +50 °C	-10 °C
X3, breakpoint, outdoor air temp.	-50 – +50 °C	+10 °C
X4, breakpoint, outdoor air temp.	-50 – +50 °C	+20 °C
<i>Supply air, flow</i>		
Y1, breakpoint, supply air	¹⁾	25% of max. airflow for air handling unit
Y2, breakpoint, supply air	¹⁾	25% of max. airflow for air handling unit
Y3, breakpoint, supply air	¹⁾	25% of max. airflow for air handling unit
Y4, breakpoint, supply air	¹⁾	25% of max. airflow for air handling unit
<i>Extract air, flow</i>		
Y1, breakpoint, extract air	¹⁾	25% of max. airflow for air handling unit
Y2, breakpoint, extract air	¹⁾	25% of max. airflow for air handling unit
Y3, breakpoint, extract air	¹⁾	25% of max. airflow for air handling unit
Y4, breakpoint, extract air	¹⁾	25% of max. airflow for air handling unit
<i>Supply air, pressure</i>		
Y1, breakpoint, supply air	20-750 Pa	100 Pa
Y2, breakpoint, supply air	20-750 Pa	100 Pa
Y3, breakpoint, supply air	20-750 Pa	100 Pa
Y4, breakpoint, supply air	20-750 Pa	100 Pa
<i>Extract air, pressure</i>		
Y1, breakpoint, extract air	20-750 Pa	100 Pa
Y2, breakpoint, extract air	20-750 Pa	100 Pa
Y3, breakpoint, extract air	20-750 Pa	100 Pa
Y4, breakpoint, extract air	20-750 Pa	100 Pa

¹⁾ See table for min./max. flows in Section 6.4.1.2

Outdoor air compensation

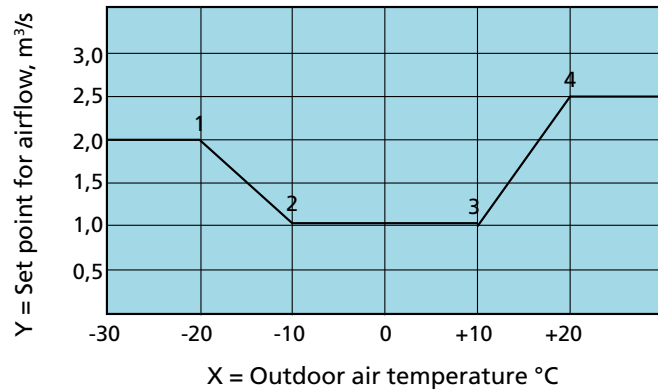

Example:

Flow regulated air handling unit The same principle can be applied to a pressure regulated AHU, however this will cause a reduction in pressure in Pa.

If the outdoor air temperature is under -20 °C (X1), the flow set point will be a constant 2.0m³/s (Y1).

If the outdoor air temperature is between -20 °C (X1) and -10 °C (X2), the airflow will decrease from 2.0 m³/s (Y1) to 1.0 m³/s (Y2) as shown in the curve.

If the outdoor air temperature is between -10 °C (X2) and 10 °C (X3), the flow set point will be a constant 1.0 m³/s (Y2 and Y3).

If the outdoor air temperature is between 10 °C (X3) and 20 °C (X4), the airflow will increase from 1.0 m³/s (Y3) to 2.5 m³/s (Y4) as shown in the curve.

If the outdoor air temperature is over 20 °C (X4), the flow set point will be a constant 2.5 m³/s.

4.1.9 Booster diffusers

The function for Booster diffusers is used for controlling the air damper inside the air terminal and can be activated for heating or cooling. Heating or cooling is modulated depending on whether the supply air is warmer or colder than the room/extract air. An indicator is displayed if heating or cooling is active.

The IQlogic+ module, TBIQ-3-2, accessory is required.

Booster diffusers

Value	Setting range	Factory setting
Booster diffusers	On/Off	Off

4.1.10 Automatic operation

Density-corrected airflow

The density of the air is different at different temperatures. This means that a specific volume of air changes at various air densities. The AHU automatically corrects this, so that correct air volume is always obtained.

The control equipment always displays the corrected airflow.

Pressure balance corrected extract airflow

The extract airflow is corrected by continuously measuring the pressure balance across the rotary heat exchanger. The extract airflow is guaranteed with consideration given to the air purging and leakage air flow.

4.2 Temperature

N.B.! If the entry of new temperature settings involve large changes, you should first stop the AHU before you enter the new settings.

Specific temperatures, such as set points, should be specified in °C or °F, whereas displacements, deviations and differentials should be specified in K (Kelvin).

If only GOLD SD supply air handling units are installed, they require an external room sensor for ERS, ORE and extract air regulation.

4.2.1 Status

All the relevant values can be read here. Used for performance checks.

4.2.2 Settings

ERS Regulation 1

ERS regulation refers to Extract air temperature-Related Supply air temperature regulation. This means that the temperature of the supply air is regulated in relation to the temperature of the extract air.

Under normal circumstances, the supply air temperature is regulated to be a few degrees lower than the extract air temperature. In this way, the heat exchanger will provide optimal performance, and this means excellent operating economy. ERS control is suitable for use when there is surplus heat in the premises generated e.g. by machinery, lighting or people, and the premises have supply air diffusers suitable for discharging air below room temperature.

ERS Regulation 1

The control unit regulates the ratio between the supply air and extract air temperature according to a factory-preset curve.

See the diagram to the right.

The step in the curve, breakpoint and differential can be changed.

Settings:

Value	Setting range	Factory setting
Extract related supply air-1 step	1 - 4	2
Extract related supply air-1 diff	1-7 K	3 K
Extract related supply air-1 breakpoint (refers to extract air temperature)	12-26 °C	22 °C

The setting range for breakpoint and deviation are limited by the min. and max. settings.

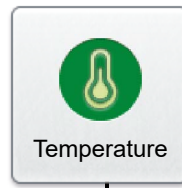

ERS Regulation 1

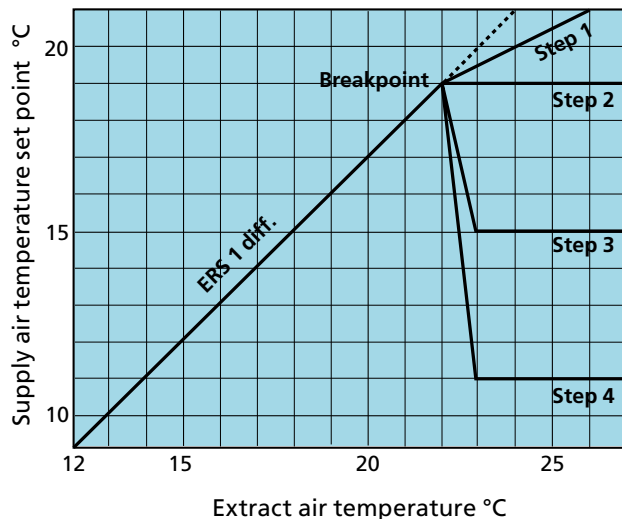

Factory setting means:

If the extract air temperature is below 22 °C (breakpoint), the supply air temperature set point will be automatically regulated to be 3 K (diff.) lower.

If the extract air temperature is above 22 °C, the supply air temperature set point will constantly be 19 °C (step 2).

ERS Regulation 2

Used if the factory preset performance curve in the ERS Control 1 function does not provide the results desired to meet special needs and conditions. Depending on which setting have been entered, the installation of an air heater for reheating may be required.

An individually adjusted curve regulates the ratio between the supply air and the extract air temperature. The curve has four adjustable breakpoints.

See the diagram to the right.

Settings:

Value	Setting range	Factory setting
<i>Extract air temperature</i>		
Extract related supply air-2 X1	10-40 °C	15 °C
Extract related supply air-2 X2	10-40 °C	20 °C
Extract related supply air-2 X3	10-40 °C	22 °C
Extract related supply air-2 X4	10-40 °C	22 °C
<i>Supply air temperature set point</i>		
Extract related supply air-2 Y1	10-40 °C	20 °C
Extract related supply air-2 Y2	10-40 °C	18 °C
Extract related supply air-2 Y3	10-40 °C	14 °C
Extract related supply air-2 Y4	10-40 °C	12 °C

The set point displacement and Summer night cool functions can also affect the preset temperatures.

Supply air regulation

Supply air regulation involves maintaining a constant supply air temperature without consideration to the load in the premises.

This type of regulation can be used when the load and temperatures of the premises are predictable. In most cases this requires the installation of an air heater for reheating, possibly an air cooler as well.

Settings:

Value	Setting range	Factory setting
Supply air (temp. set point)	0-40 °C	21 °C

Extract air regulation

Extract air control involves maintaining a constant temperature in the extract air duct (the premises), by regulating the supply air temperature.

This provides a uniform temperature in the premises regardless of the load and this type of regulation requires the installation of an air heater for reheating; possibly a cooling coil as well.

The extract air temperature is measured by the air handling unit's internal temperature sensor. If this internal temperature sensor does not give an adequate representative extract air temperature reading, an external room temperature sensor can be installed and wired to the control unit's communications BUS (optional COM1-3).

Settings:

Value	Setting range	Factory setting
Extract air (temp. set point)	0-40 °C	21 °C
Supply air, min.	0-30 °C	16 °C
Supply air, max.	8-50 °C	28 °C

ERS Regulation 2

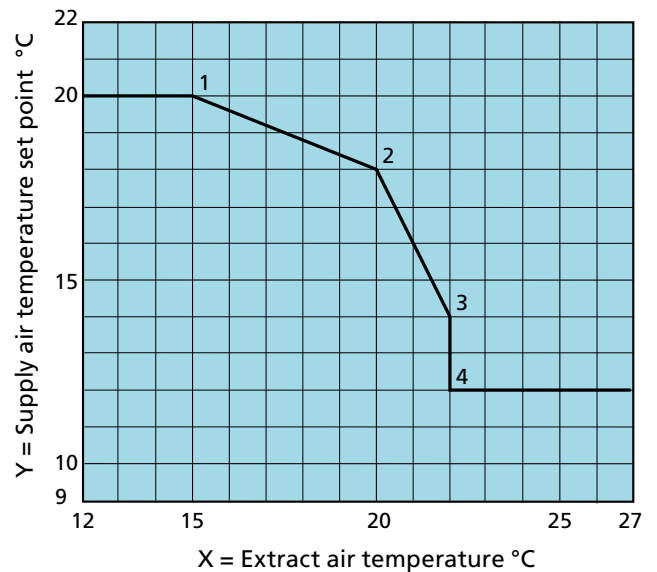

Breakpoints according to factory setting involve the following:

If the extract air temperature is below 15°C (X1), the supply air temperature set point will constantly be 20 °C (Y1).

If the extract air temperature is between 15 °C (X1) and 20 °C (X2), the supply air temperature set point is regulated from 20 °C (Y1) down to 18 °C (Y2) as shown in the curve.

If the extract air temperature is between 20 °C (X2) and 22 °C (X3), the supply air temperature set point is regulated from 18 °C (Y2) down to 14 °C (Y3) as shown in the curve.

When the extract air temperature is 22 °C (X4), the supply air temperature set point is regulated from 14 °C (Y3) down to 12 °C (Y4).

If the extract air temperature is over 22 °C (X4), the supply air temperature set point will constantly be 12 °C (Y4).

Seasonal controlled temperature regulation

Seasonal controlled temperature regulation makes it possible to have two temperature regulation modes that alternate at preset outdoor temperatures.

Seasonal controlled temperature regulation operates with the air handling unit's internal temperature sensor, however for the best performance we recommend external outdoor temperature sensor TBLZ-1-24-3; see separate installation instructions.

If the ordinary temperature and seasonal controlled temperature regulation are to be of different types, these can be combined freely, for example, ordinary temperature regulation = ERS 1 and seasonal controlled temperature regulation = supply air.

In instances where the same type of ordinary temperature regulation and seasonal controlled temperature regulation are desired, this can be selected for supply air control and extract air control. Values for seasonal controlled temperature regulation can then be set independently of values for ordinary temperature regulation.

Settings:

Value	Setting range	Factory settings
Seasonal controlled supply air	0-40 °C	21 °C
Seasonal controlled extract air	0-40 °C	21 °C
Seasonal controlled supply air min.	0-30 °C	16 °C
Seasonal controlled supply air max.	8-50 °C	28 °C

ORS regulation

ORS regulation refers to Outdoor air temperature-Related Supply air temperature regulation. This means that the temperature of the supply air is regulated in relation to the temperature of the outdoor air.

An individually adjusted curve regulates the ratio between the supply air and the outdoor air temperature. The curve has four adjustable breakpoints.

Settings (see also diagram to the right):

Value	Setting range	Factory setting
<i>Outdoor air temperature</i>		
Outdoor related supply air X1	-50 – +50 °C	-20 °C
Outdoor related supply air X2	-50 – +50 °C	-10 °C
Outdoor related supply air X3	-50 – +50 °C	10 °C
Outdoor related supply air X4	-50 – +50 °C	20 °C
<i>Supply air temperature set point</i>		
Outdoor related supply air Y1	10 – 40 °C	21.5 °C
Outdoor related supply air Y2	10 – 40 °C	21.5 °C
Outdoor related supply air Y3	10 – 40 °C	21.5 °C
Outdoor related supply air Y4	10 – 40 °C	21,5 °C

ORS regulation

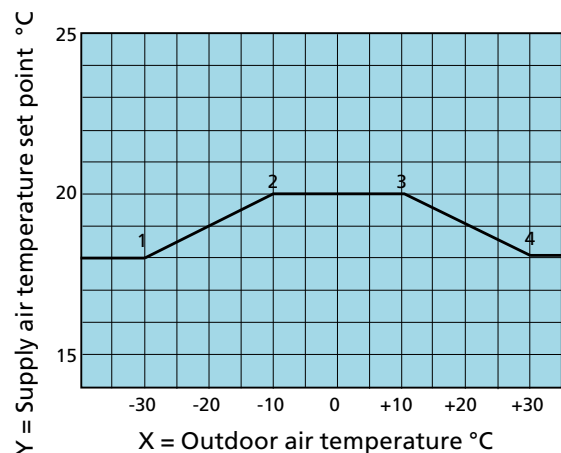

Example:

If the outdoor air temperature is under -30 °C (X1), the supply air temperature set point will constantly be 18 °C (Y1).

If the outdoor air temperature is between -30 °C (X1) and -10 °C (X2), the supply air temperature set point is regulated from 18 °C (Y1) up to 20 °C (Y2) as shown in the curve.

If the outdoor temperature is between -10 °C (X2) and +10 °C (X3) the supply air set point will constantly be 20 °C (Y3).

If the outdoor air temperature is between +10 °C (X3) and +30 °C (X4), the supply air temperature set point is regulated from 20 °C (Y3) down to 18 °C (Y4) as shown in the curve.

If the outdoor air temperature is over 30 °C (X4), the supply air temperature set point will constantly be 18 °C (Y4).

ORE regulation

ORE regulation refers to Outdoor air temperature-Related Extract air temperature regulation. This means that the extract air temperature is regulated in relation to the outdoor air temperature.

An individually adjusted curve regulates the ratio between the extract air and the outdoor air temperature. The curve has four adjustable breakpoints.

Settings (see also diagram to the right):

Value	Setting range	Factory setting
Supply air, min.	0 – 20 °C	16 °C
Supply air, max.	16 – 50 °C	28 °C
<i>Outdoor air temperature</i>		
Outdoor related extract air X1	-50 – +50 °C	-20 °C
Outdoor related extract air X2	-50 – +50 °C	-10 °C
Outdoor related extract air X3	-50 – +50 °C	10 °C
Outdoor related extract air X4	-50 – +50 °C	20 °C
<i>Extract air temperature set point</i>		
Outdoor related extract air Y1	10 – 40 °C	21,5 °C
Outdoor related extract air Y2	10 – 40 °C	21,5 °C
Outdoor related extract air Y3	10 – 40 °C	21,5 °C
Outdoor related extract air Y4	10 – 40 °C	21,5 °C

4.2.3 Regulation mode

Select ordinary temperature control ERS 1, ERS 2, Supply air, Extract air, ORS or ORE.

If desirable, seasonal controlled temperature regulation is enabled and the required temperature regulation (ERS 1, ERS 2, Supply air, Extract air, ORS or ORE) is selected.

Set the temperature at which seasonal controlled temperature regulation shall be enabled and disabled respectively. By setting a span between the different temperatures, unwanted switching operations between ordinary and seasonal controlled temperature regulation can be avoided.

Note that seasonal control temperature regulation is activated at a temperature below 0 °C (factory setting, adjustable) and is deactivated at 20 °C (factory setting, adjustable). When the function is deactivated the temperature must drop below 0 °C (factory setting, adjustable) in order to be reactivated.

Settings:

Value	Setting range	Factory setting
Temperature control	ERS 1/ERS 2/Supply air/Extract air/ORS/ORE	Supply air
Seasonal controlled temperature regulation	On/Off	Off
Seasonal controlled temperature regulation	ERS 1/ERS 2/Supply air/Extract air/ORS/ORE	Extract air
Seasonal controlled temperature regulation, enabled	-20 – +40 °C	0 °C
Seasonal controlled temperature regulation, disabled	-20 – +40 °C	20 °C

ORE regulation

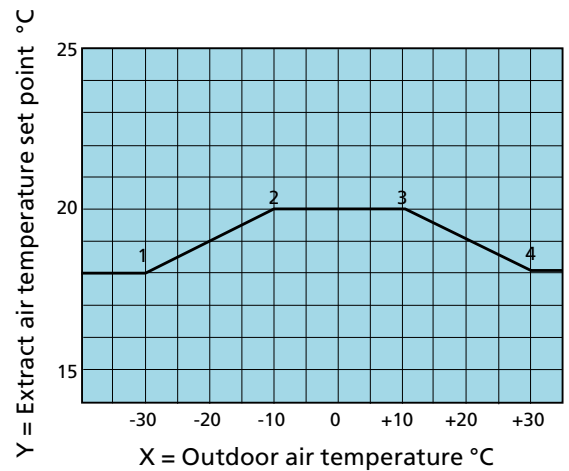

Example:

If the outdoor air temperature is under -30 °C (X1), the extract air temperature set point will constantly be 18 °C (Y1).
 If the outdoor air temperature is between -30 °C (X1) and -10 °C (X2), the extract air temperature set point is regulated from 18 °C (Y1) up to 20 °C (Y2) as shown in the curve.
 If the outdoor temperature is between -10 °C (X2) and +10 °C (X3) the extract air set point will constantly be 20 °C (Y3).
 If the outdoor air temperature is between +10 °C (X3) and +30 °C (X4), the extract air temperature set point is regulated from 20 °C (Y3) down to 18 °C (Y4) as shown in the curve.
 If the outdoor air temperature is over 30 °C (X4), the extract air temperature set point will constantly be 18 °C (Y4).

Regulation mode

4.2.4 Unit of temperature

The desired unit of temperature can be set.

Settings:

Value	Setting range	Factory settings
Unit	°C/ °F	°C

Unit of temperature

4.2.5 Set point displacement

Used for changing the supply air and extract air temperature set points by means of an external 0-10 VDC signal. For example, the temperature can be increased or decreased at certain times of the day by means of an external timer or potentiometer.

The accessory, IQlogic+ module TBIQ-3-2, is required.

The set point can be influenced by ± 5 °C.

If the AHU is operating in the supply air regulation or ORS regulation mode, the supply air temperature set point is displaced and the AHU is operating in the extract air regulation or ORE regulation mode, the extract air temperature set point is displaced.

When the AHU is operating in the ERS regulation 1 mode, the difference between extract air and supply air is influenced. The difference cannot be less than 0 °C. The difference will decrease as the input signal increases.

If the AHU is operating in the ERS regulation 2 mode, the supply air set point will be displaced.

When the function is activated, the set point is displaced as plotted in the diagram to the right.

Set point displacement will not affect any possible extra temperature zone (Xzone) which regulates according to its ordinary set point if set point displacement is in operation.

Settings:

Value	Setting range	Factory setting
Set point displacement	On/Off	Off

Set point displacement

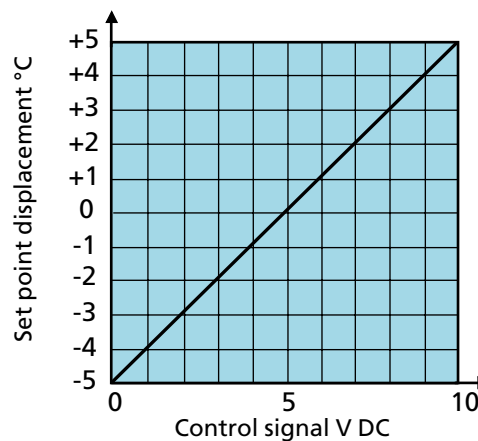

Set point displacement involves the following:
 Control signal 0 V DC: The set point is decreased by 5 °C.
 Control signal 5 V DC: No change in set point.
 Control signal 10 V DC: The set point increases by 5 °C.

4.2.6 Night compensation

The function is activated when a lower temperature setpoint is required at night.

The required reduction in temperature is set and the time interval for the night reduction programmed via two time channels.

The function can be used only in combination with supply air regulation or extract air/room regulation

Settings:

Value	Setting range	Factory setting
Night compensation	On/Off	Off
Night reduction	-10 – 0 K	-2.0 K
Time channel 1/2, start of night	00:00 - 23:59	00:00
Time channel 1/2, end of night	00:00 - 23:59	00:00
Time channel 1/2, period	Inactive/Monday/Tuesday/Wednesday/Thursday/Friday/Saturday/Sunday/Monday-Friday/Monday-Sunday/Saturday-Sunday	Inactive

Night compensation

4.2.7 Neutral zone

The neutral zone prevents the cooling and heating systems from counteracting each other.

The preset neutral zone is added to the set point for heating and the sum of these provides the set point for cooling.

When extract air regulation is active, the supply air set point is not affected. The neutral zone has no effect if the unit is operating in the ERS regulation mode.

Settings:

Value	Setting range	Factory setting
Supply air, temperature control	0.0 - 10 K	0.5 K
Extract air, temperature control	0.0 - 10 K	0.5 K

Neutral zone

4.2.8 External temperature sensors

An extract air duct temperature sensor, TBLZ-1-76, can be connected to the air handling unit's control circuit card. See separate instructions for installation.

Up to four external room temperature and/or outdoor temperature sensors can be wired to the air handling unit's control circuit card. The TBLZ-1-24-2 room temperature sensor or TBLZ-1-24-3 outdoor temperature sensor accessories should be used. See separate installation instructions.

The sensor can be selected to control only intermittent night heat and/or summer night cooling (the AHU is then controlled during the daytime in response to signals from the internal sensor inside the AHU).

Locate the temperature sensors at suitable places to obtain representative readings.

The air handling unit is controlled in response to a computed mean value of the temperature sensors' readings, alternatively in response to signals from the temperature sensor that measures the lowest or highest value.

As an alternative, a temperature reading can be transmitted to the air handling via communication from e.g. a main system.

The same provision is available for room sensors for the Xzone function.

Settings:

Value	Setting range	Factory setting
Extract air duct, temperature sensor	On/Off	Off
Room sensor 1	On/Off	Off
Room sensor 2	On/Off	Off
Room sensor 3	On/Off	Off
Room sensor 4	On/Off	Off
Room sensor function	Medium/min./Max.	Medium
Room temperature from communication	On/Off	Off
Room temperature, for intermittent night heat only	On/Off	Off
Room temperature, for summer night cooling only	On/Off	Off
Outdoor air sensor 1	On/Off	Off
Outdoor air sensor 2	On/Off	Off
Outdoor air sensor 3	On/Off	Off
Outdoor air sensor 4	On/Off	Off
Outdoor air sensor function	Medium/min./Max.	Medium
Outdoor temperature from communication	On/Off	Off

External temperature sensors

4.2.9 Regulation sequence

Heating mode

The mutual order for the heating mode regulation sequence can be selected as specified below.

Functions that have not been selected have no effect on the relevant regulation sequence.

Value	Setting range	Factory setting
Heating mode	1/2/3/4/5/6*	1

- * 1 = HX - Extra regulation sequence - ReCO₂ - HC - Reheating - Down regulation of the fan
 2 = HX - Extra regulation sequence - Reheat - ReCO₂ - HC - Down regulation of fan
 3 = HX - Reheating - ReCO₂ - HC - Extra regulation sequence - Down regulation of the fan
 4 = HX - Reheating - Extra regulation sequence - ReCO₂ - HC - Down regulation of fan
 5 = HX - ReCO₂ - HC - Reheating - Extra regulation sequence - Down regulation of the fan
 6 = HX - ReCO₂ - HC - Extra regulation sequence - Reheating - Down regulation of the fan

HX (heat exchanger):

The temperature efficiency of the air handling unit's heat exchanger is modulated to provide max. heat recovery.

Extra regulation sequence:

Used in the heating mode for air heater (if required), air recirculation damper, etc.

ReCO₂:

Recirculated air is variably mixed in up to the lowest permissible supply airflow. Assumes inclusion of the TCBR air recirculation section accessory.

HC:

HC in the heat pump function starts to produce heating.

Reheating:

Air heater for reheating provides heating capacity.

Down regulation of fan:

Down regulation can be selected for supply air only or supply air and extract air.

Regulation sequence

Cooling mode

The mutual order for the cooling mode regulation sequence can be selected as specified below.

Functions that have not been selected have no effect on the relevant regulation sequence.

Value	Setting range	Factory setting
Cooling mode	1/2/3/4/5/6*	1

- * 1 = HX - Cooling boost - Extra regulation sequence - ReCO₂ - HC - Cool
- 2 = HX - Cooling Boost - Extra regulation sequence - Cooling - ReCO₂ - HC
- 3 = HX - Cooling Boost - Cooling - ReCO₂ - HC - Extra regulation sequence
- 4 = HX - Cooling Boost - Cooling - Extra regulation sequence - ReCO₂ - HC
- 5 = HX - ReCO₂ - HC - Cooling Boost - Cooling - Extra regulation sequence
- 6 = HX - ReCO₂ - HC - Cooling Boost - Extra regulation sequence - Cool

HX (heat exchanger):

The temperature efficiency of the air handling unit's heat exchanger is modulated to provide max. cool recovery.

Cooling Boost (Economy):

Involves increasing the supply air and extract air airflows to convey more cooling energy to the premises. The flow increase takes place between the current flow and the preset max. flow.

Extra regulation sequence:

Used in the cooling mode for air cooler (if required), etc.

ReCO₂:

Recirculated air is variably mixed in up to the lowest permissible supply airflow. Assumes inclusion of the TCBR air recirculation section accessory.

HC:

HC in the chiller function starts to produce cooling.

Cooling:

Air cooler provides cooling capacity.

4.2.10 Min. exhaust air

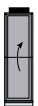

The min. exhaust air function can be used whenever the exhaust air temperature is not permitted to be below a predetermined value.

Min. exhaust air

The function controls the heat exchanger rotor speed (efficiency) in order to limit the exhaust air temperature to the required value. The function decelerates the heat exchanger rotor speed from the current level, until the exhaust air temperature reaches the preset minimum permissible setting.

Exhaust air regulation requires a separate TBLZ-1-58-aa temperature sensor (accessory) fitted in the AHU's exhaust air.

See separate installation instructions for the TBLZ-1-58-aa Internal temperature sensor.

Settings:

Value	Setting range	Factory setting
Min. exhaust air	On/Off	Off
Min. exhaust air temperature	-40 – + 20,0 °C	5.0 °C

4.2.11 Morning Boost

The unit is utilised for heating the premises during a preset period prior to the switch-in time set on the timer.

The function is used if an air recirculation section is installed.

The AHU starts up prematurely and uses the same temperature regulation settings. The airflow / air pressure is adjustable.

When the function starts, the air recirculation damper opens and the supply air fan starts up. The extract air fan and the outdoor air damper remain closed.

Settings:

Value	Setting range	Factory setting
Morning Boost	On/Off	Off
Start time (before the ordinary start time according to the timer)	hour:min.	00:00
Supply air, set point	¹⁾	50% of max. supply air for AHU alt. 100 Pa

¹⁾ The setting range is the same as the AHU's min./max. setting for flow regulation and 10-750 Pa for pressure regulation

Morning Boost

4.2.12 Heating Boost

Heating boost (forced heating) means that the air handling unit, operating in the normal flow regulation mode, increases both the supply airflow and the extract airflow in order to carry more heat into the premises.

The fans are permitted to operate in the range between current flow modes or pressure (low speed, high speed) and the preset max speed. See Section 6.4.1.2.

The functions operates only when the AHU is operating in the extract air regulation and ORE regulation mode. If demand control or boost is selected in combination with heating boost, the flow is controlled by the function that transmits the highest output signal to the fans.

A regulated ramp function switches in and gradually increases the airflow when there is a heating load, and the supply air temperature is 3 K (preset at factory) lower than the preset max. supply air temperature.

Settings:

Value	Setting range	Factory setting
Heating Boost	On/Off	Off
Start limit	2-10 K	3 K

Heating Boost

4.2.13 Cooling Boost

Cooling Boost (forced cooling) means that the supply air and extract air airflows are increased to convey more cool air to the premises.

The fans are permitted to operate in the range between current flow modes or pressure (low speed, high speed) and the preset max speed. See Section 4.1.2.

The function can be selected in five variants as follows:

Comfort

The cooling outputs are activated if there is a cooling load.

A regulated ramp function switches in and gradually increases the airflow when there is a cooling load, and the supply air temperature is 3 K (preset at factory) higher than the preset max. supply air temperature.

Economy

Cooling Boost Economy initially uses a higher airflow to cool the premises, before a start signal is transmitted to chillers.

The function can also operate without the cooling function activated.

In the event of a cooling load, the airflows are slowly increased up to preset maximum flow. When the flows are up to max and if a cooling load is still present, the output contacts for cooling are activated.

The function requires that the outdoor air temperature is at least 2 K lower than the extract air temperature for it to be activated. The normal cooling function is activated if the temperature difference is too small.

Sequence

The Cooling Boost Sequence is used if a chiller is sized for a higher cooling flow than normal flow.

If there is a cooling load, the flow is increased up to the preset max. flow and the cooling function is activated afterwards.

The Cooling Boost Sequence is blocked if no cooling function has been selected.

Comfort and economy

The comfort variant and the economy variant can be combined. The function that has the highest signal (highest setpoint) applies.

Economy and sequence

The economy variant and the sequence variant can be combined. The function that has the highest signal (highest setpoint) applies.

Sequence and comfort

The sequence variant and the comfort variant can be combined. The function that has the highest signal (highest setpoint) applies.

Comfort, economy and sequence

The comfort variant, economy variant and the sequence variant can be combined. The function that has the highest signal (highest setpoint) applies.

Cooling Boost

Settings:

Value	Setting range	Factory setting
Cooling Boost	Inactive Comfort Economy Sequence Comfort and economy Economy and sequence/ Sequence and comfort/ Comfort, economy and sequence	Inactive
Start limit (Comfort)	2-10 K	3 K

4.2.14 Intermittent night heat

The AHU is utilized for heating the premises when it is normally stopped by timer.

The function requires that an external room sensor is wired to the control unit's communication BUS (optional COM 1-3) and that the AHU is fitted with an air heater for reheating the air. The function works best if the GOLD is equipped with an air recirculation section and shut-off dampers for the outdoor air and the exhaust air.

When the function is activated, the air handling unit detects when the room temperature drops below the preset start temperature. The unit starts with preset flows and the supply air temperature set point. At the same time, the damper in the air recirculation section opens, if one is installed.

If recirculation is in the Off position, the extract air fan is operating and the damper relay is open. The extract airflow setting can be decreased to the air handling unit's min. flow.

Intermittent night heat does not affect any possible extra temperature zone (Xzone) which regulates according to its ordinary set point if Intermittent night heat is in operation.

Conditions to be met for intermittent night-time heating to start:

- The AHU must be set to normal stop or extended normal stop.
- The room temperature must be lower than the preset start temperature.

Conditions to be met so that Intermittent night heat will stop:

- The air handling unit is running at normal low/high speed or external/manual stop has been activated.
- The room temperature exceeds the preset stop temperature.
- The alarm with preset stop priority trips. (If needed, the air handling unit fans will continue to operate to cool the electric air heater although other conditions for stop have been met.)

Settings:

Value	Setting range	Factory setting
Intermittent night heat	On/Off	Off
Air recirculation	On/Off	On
Room temperature, start	5 - 25 °C	16 °C
Room temperature, stop	5 - 25 °C	18 °C
Supply air temperature, set point	5 - 50 °C	28 °C
Supply airflow, set point	¹⁾	50% of max. supply air for AHU alt. 100 Pa
Extract air flow, set point	¹⁾	50% of max. supply air for AHU alt. 100 Pa

¹⁾ The setting range is the same as the AHU's min./max. setting for flow regulation and 10-750 Pa for pressure regulation

Intermittent night heat

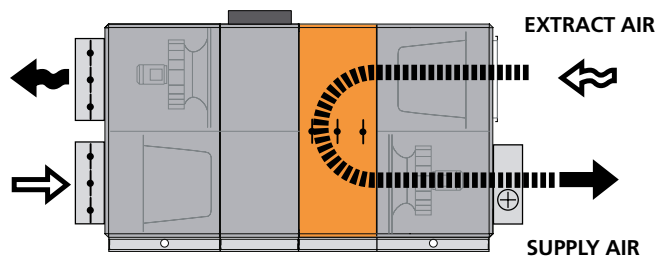

Intermittent night heat with air recirculation section:

Recirculation in the On position:

When conditions for start are met, outdoor air and exhaust air shut-off dampers remain closed. The damper in the air recirculation section opens. The extract air fan is idle.

The supply air fan operates according to the preset supply airflow and the air heater for reheating operates according to the preset supply air temperature set point, until the conditions for stop are met.

4.2.15 Summer night cool

The lower temperature at night is utilised to cool down the building structure. This reduces the cooling load during the first hours of the day. If a cooling unit is installed, it will not need to be operated, thus offering savings. If no cooling unit is installed, a certain cooling effect will still be achieved.

When the function is activated, the AHU fans operate at high speed, with a supply air set point of 10 °C (factory setting) from the preset time until the conditions necessary for stop are satisfied.

If the air handling unit is stopped for a period of time, test starts can be implemented in order to check whether all conditions, except heating demand, for summer night cooling have been met. If the conditions have been met, summer night cooling can be run. The start and stop dates of the period during which the air handling unit will be stopped can be preset.

The set point for flow or pressure on the supply air and extract air can be set. This then means that any outdoor compensation does not affect summer night cooling.

An extra temperature zone (Xzone), if required, obtains the same supply air set point if Summer night cool is in operation.

Conditions that must be met for Summer night cool to start at the preset time:

- The time is between the preset start time and stop time.
- The outdoor air temperature shall be higher than the preset value.
- The extract air temperature shall be higher than the preset value.
- The extract air is at least 2 °C warmer than the outdoor air.
- Heating load has not been required between 12.00 and 23.59 hours (heating load for dehumidification is not registered as heating load).¹⁾
- The air handling unit shall be running at low speed or be in the normal stop operating mode.
- Intermittent night heat has not been active during the day.

Conditions that must be met for Summer night cool to stop:

- The time is not between the preset start time and stop time.
- The extract air temperature drops below the preset value.
- The outdoor temperature drops below the preset value.
- The extract air is less than 1 °C warmer than the outdoor air.
- The air handling unit is running at normal high speed or external/manual stop has been activated.

The function starts once per preset time period.

Summer night cool

Settings:

Value	Setting range	Factory setting
Summer night cool	On/Off	Off
Start time	00:00-00:00	23:00
Stop time	00:00-00:00	06:00
Outdoor air, start	-5 - +15 °C	10 °C
Extract air, start	17 - 27 °C	22 °C
Extract air, stop	12 - 22 °C	16 °C
Supply air, set point	0 - 20 °C	10 °C
Start, period with stopped air handling unit ¹⁾	01-01 – 01-01 (month – day)	05-01
Stop, period with stopped air handling unit ¹⁾	01-01 – 01-01 (month – day)	10-01
Supply air, set point	Unit's minimum flow - maximum flow ²⁾	50% of maximum air flow for air handling unit 100 Pa
Supply air, set point	20 - 750 Pa	
Extract air set point	Unit's minimum flow - maximum flow ²⁾	50% of maximum air flow for air handling unit 100 Pa
Extract air set point	20 - 750 Pa	

¹⁾ The condition for heating load can be deselected during the preset period.

²⁾ See section 4.1.2.

4.2.16 Down regulation (airflow/pressure)

Down regulation of the supply air flow is the last step in the regulation sequence for heating. The supply air fan or both the supply air and extract air fan can be selected. The extract air fan only cannot be selected.

See also Section 4.2.8.

Down regulation can take place to max. of 50% of the preset value, however not lower than the min. flow or 20 Pa.

Settings:

Value	Setting range	Factory setting
Down regulation	Inactive/Supply air/Supply air and extract air	Inactive

Down regulation

4.3 Time and schedule

The built-in timer enables you to control the AHU's operating mode/time. Certain other oversteering functions such as external timer, communication, etc. affect the preset operating modes.

There are five different operating modes:

Total stop = The AHU is completely stopped, no internal automatic functions or external control commands can start the AHU.

Normal Stop = The AHU has stopped, however all the internal and external automatic functions oversteer the stop.

Extended Normal Stop = The AHU has stopped, however all the internal and external automatic functions, with exception of Summer night cool, oversteer the stop.

Low speed = The AHU is running at the preset low speed setting.

High speed = The AHU is running at the preset high speed setting.

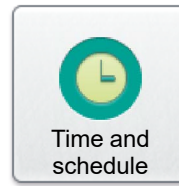

4.3.1 Time and date

The current date and time can be set and adjusted if needed. The timer automatically takes leap years into consideration.

The relevant region and city can be selected, summer time/winter time changover will then be managed automatically.

Time source can be set to manual or via SNTP (requires connection to network) and BACnet. The time format and date format can be set.



4.3.2 Schedule settings

The relevant operating mode can be read under Schedule settings. Here you can also set a preselected operating mode, in which the air handling unit always operates during non-programmed time, under Day schedule and Exceptions schedule. This setting (start and stop date not activated) is used most often and covers the majority of needs.

When the start and stop date is activated, this means that during the preset period (date) preset time applies during the day schedule and the exceptions schedule, and at all other times the AHU runs in the preselected operating mode.

Settings:

Value	Setting range	Factory settings
Preselected operating mode	Total stop/Low speed/High speed/Normal Stop/Extended Normal Stop	Low speed
Start date	Active/Inactive	Inactive
Start date	Year/Month/Day	
Stop date	Active/Inactive	Inactive
Stop date	Year/Month/Day	



4.3.3 Day schedule

Times and days can be set when the air handling unit is to run in the high speed mode, low speed mode or be switched off.

For each day (Monday - Sunday), six different events can be set to occur at a given point in time. Here, it is also possible to set six different events for two exceptions under Ex1 and Ex2. The provisions for these exceptions can then be set under Exceptions schedule, Calendar 1 and Calendar 2.

Note that the preset event will not be carried over to the next 24-hour period. If no event is set from 00.00 hours of the next 24-hour period, the AHU will operate in the pre-selected operating mode preset under Schedule settings.

Settings:

Value	Setting range	Factory settings
Day	Mon/Tues/Wed/Thurs/Fri/Sat/Sun/Ex1/Ex2	
Time	00:00-23:59	00:00
Action	Inactive/Total stop/Low speed/High speed/Normal Stop/ Extended Normal Stop/Ignore	Inactive

Day schedule

4.3.4 Exceptions schedule

Possible exceptions (Ex1 and Ex2), previously preset in the day schedule can be set in the Exceptions schedule. Here you can determine on which date or weekday the relevant exception shall apply. If you select Calendar 1 or Calendar 2, which is the most often the case, these can be set according to particulars in the next section.

Settings:

Value	Setting range	Factory settings			
<i>Exceptions schedule 1/2</i> Exceptions method	Inactive/Date/Date range/Weekday/Calendar 1/Calendar 2	Inactive	Stop weekday	Each day/ Monday/Tuesday/ Wednesday/ Thursday/Friday/ Saturday/Sunday	Each day
<i>Date</i> Start date Start weekday	Year/Month/Day Each day/ Monday/Tuesday/ Wednesday/ Thursday/Friday/ Saturday/Sunday	Each day	<i>Weekday</i> Start date	Mon 1-12/Odd/ Even/Each Day 1-7/8-14/15- 21/22-28/29-31/ Latest 7 days/Each day	
<i>Date range</i> Start date Start weekday	Year/Month/Day Each day/ Monday/Tuesday/ Wednesday/ Thursday/Friday/ Saturday/Sunday	Each day	Start weekday	Each day/ Monday/Tuesday/ Wednesday/ Thursday/Friday/ saturday/Sunday	Each day
Stop date	Year/Month/Day		Calendar 1 Calendar 2	See next chapter See next chapter	

Exceptions schedule

4.3.5 Calendar 1 and 2

The specific days when Exceptions schedule 1 or 2 shall apply can be set in Calendars 1 and 2. On condition that Calendar 1 or 2 is selected, see previous section. In other cases, these settings will have no effect.

There is a total of ten possible settings under each calendar and various functions can be selected for each.

Settings (For Calendar 1 and Calendar 2 respectively):

Value	Setting range	Factory setting
Function 1-10	Inactive/Date/Date range/ Weekday	Inactive
<i>Date</i>		
Start date	Year/Month/Day	
Start weekday	Each day/Monday/Tuesday/ Wednesday/Thursday/Friday/ Saturday/Sunday	Each day
<i>Date range</i>		
Start date	Year/Month/Day	
Stop date	Year/Month/Day	
<i>Weekday</i>		
Start date	Month 1-12/Odd/Even/Each Day 1-7/8-14/15-21/22-28/29- 31/Latest 7 days/Each day	
Start weekday	Each day/Monday/Tuesday/ Wednesday/Thursday/Friday/ Saturday/Sunday	Each day

Calendar 1

Calendar 2

4.3.6 Prolonged operation

The control unit inputs for external low speed (terminals 14-15) and external high speed (terminals 16-17) respectively, can be supplemented with Prolonged operation. They can be used for overtime running activated by a pushbutton, for example.

The required time in hours and minutes can be set as follows.

Settings:

Value	Setting range	Factory setting
Ext. low speed	0:00 - 23:59	00:00
Ext. high speed	0:00 - 23:59 (hrs.:min.)	00:00 (hrs.:min.)

Prolonged operation

4.4 Energy monitoring

Readings of the power consumed by fans and other AHU components can be viewed here. SFP readings for the AHU fans and the efficiency on heat transfer of the rotary heat exchanger can also be viewed. Calculated capacities for re-heating can cooling can also be read. Accumulated energy consumption can be reset to zero.

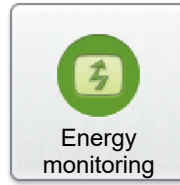

4.5 Filters

Status

The current filter status and the current alarm limit can be viewed here. Used for performance checks.

Calibration

The filters should be calibrated when the fans are started up for the first time and when the duct system, air terminals and commissioning plates, if required, have been installed and commissioned. After that every time filters are replaced. See also Section 3.

Pre-filter/AHU filter (GOLD SD)/End filter

Filter monitoring must be activated for the filter (in addition to the internal filter in the GOLD RX/PX/CX) to be monitored.

Settings:

Value	Setting range	Factory setting
Pre-filter	Inactive/Supply air/Extract air/Supply air and extract air	Inactive
AHU filters	Inactive/Supply air/Extract air/Supply air and extract air	Inactive
End filter	On/Off	Off

Alarm limits

Alarm limit for installed filters can be changed.

Setting:

Value	Setting range	Factory setting
Installed filters	0-500 Pa	100 Pa

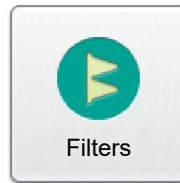

4.6 Software

The current program versions for the IQlogic control unit, IQnavigator hand-held terminal and the component units on the communications bus can be viewed and updated from the SD circuit card.

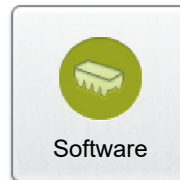

4.7 Language

The language desired can be set here. The appropriate language is normally selected the first time the AHU is started up. However, the language setting can be changed at any time.

Settings:

Value	Setting range	Factory setting
Language	Available languages are displayed	English

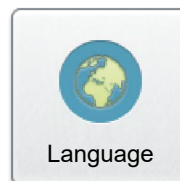

4.8 Alarm settings

4.8.1 Fire alarms

Internal fire alarm

The air handling unit's internal temperature sensors serve as fire protection thermostats. An alarm is initiated if the supply air temperature sensor registers more than 70 °C or when the extract air temperature sensor registers more than 45 °C. Alarm limits are possible to set.

If an external Extract air/Room temperature sensor is connected and activated, this works parallel with the extract air temperature sensor of the AHU.

External fire alarm 1 and 2

External fire alarm 1 (Terminals 6-7) and external fire alarm 2 (Terminals 8-9) are used for external fire-control equipment.

Alarm reset

The resetting of internal fire alarms as well as the external fire alarms 1 and 2 can be individually selected to manual or automatic.

After cool

The After cool function for electric air heaters, COOL DX and/ or SMART Link DX can be individually activated, for internal fire alarms as well as external fire alarms 1 and 2.

Fan operation at fire alarm

The fans of the air handling unit can be used for evacuating smoke, etc. It is possible to individually select the type of fan operation for each separate fire alarm.

If the AHU is idle, the fans selected start up (10-100%), irrespective of whether stop (all types) is activated.

The AHU's damper relay is energized and the AHU's operation relay is de-energized.

Dampers used must be equipped with a spring return and be for a 24 VAC supply voltage.

The damper that should be open in the event of fire shall be connected to the damper relay. Connect the damper to the control unit's terminals 28 and 30.

The damper that should be closed in the event of fire shall be connected to the operation relay. Connect the damper to the control unit's terminals 26 and 30. A jumper is placed between terminals 27 and 29.

Priority

The mutual priority of the internal and the external fire alarms can be set. If automatic is selected, this means that the first input to be activated is given priority.

Fire bypass in flow diagram

The fire bypass is shown on the hand-held terminal's flow diagram when the function is activated. Fan operation for extract air must be active for at least one of the fire alarms. Dampers switch to fire bypass if any of the fire alarms are active and the extract air fan is operational.

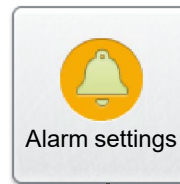

Fire alarms

Settings:

Value	Setting range	Factory settings
Internal fire alarm	On/Off	Off
Supply air temperature, alarm limit	10-90 °C	70 °C
Extract air temperature, alarm limit	10-70 °C	45 °C
Internal fire alarm reset	Manual/Auto	Manual
Internal fire alarm after cool	Active/Inactive	Inactive
External fire alarm 1/2, resetting	Manual/Auto	Manual
External fire alarm 1/2, after cool	Active/Inactive	Inactive
Fan operation on an internal fire alarm	Inactive/Supply air/Extract air/Supply air and extract air	Inactive
Supply air fan on an internal fire alarm	10-100%	100%
Extract air fan on an internal fire alarm	10-100%	100%
Fan operation on external fire alarm 1/2	Inactive/Supply air/Extract air/Supply air and extract air	Inactive
Supply air fan on external fire alarm 1/2	10-100%	100%
Extract air fan on external fire alarm 1/2	10-100%	100%
Order of priority	External fire alarm 1/External fire alarm 2/Internal fire alarm/Automatic	External fire alarm 1
Fire bypass in flow diagram	On/Off	Off

4.8.2 External alarms

External alarms can be used for external functions (control unit terminals 10-11 and 12-13).

Typical uses:

- Motor protection for the circulation pump in the heating or cooling circuit.
- Service alarm actuated by smoke detectors.

Set the following: Manual or automatic alarm reset, post-cooling for electric air heater and whether the alarm shall be activated on a closed or open circuit. The alarm can be time delayed.

Settings:

Value	Setting range	Factory setting
External alarm 1 reset	Manual/Auto	Manual
External alarm 1 after cool	Inactive/Active	Active
External alarm 1 input	Closed circuit/ Open circuit	Closed circuit
External alarm 1 delay time	0-600 sec.	10 sec.
External alarm 2 reset	Manual/Auto	Manual
External alarm 2 after cool	Inactive/Active	Active
External alarm 2 input	Closed circuit/ Open circuit	Closed circuit
External alarm 2 delay time	0-600 sec.	10 sec.

External alarms

4.8.3 Temperature protection

In the GOLD PX and CX units, the sensor in the inlet of the supply air fan can be used as temperature protection. Alarm priority and whether the AHU shall stop or not in event of an alarm can be set under Alarm priority, see Section 4.8.6.

For the GOLD RX unit, it is possible to use a separate sensor and its wiring is routed to the control unit. Select sensor input 4 for supply air = right and select sensor input 3 for supply air = left.

The alarm limit and alarm delay can be set for the sensor.

Settings:

Value	Setting range	Factory settings
Temperature protection	On/Off	Off
Alarm delay	1-900 sec.	30 sec.
Alarm limit	3 – +20°C	7°C

Temperature protection

4.8.4 Temperature alarm limits



Changes in the factory-preset alarm limits should only be made if you have special reasons for doing so and you should be aware of the consequences.

Pre-heating below set point

You can preset how much the temperature downstream of the pre-heater should be permitted to be below the temperature set point before an alarm is initiated.

Supply air below/above set point

You can preset how much the supply air temperature shall be permitted to be below or above the supply air temperature set point before an alarm is initiated. The alarm for supply air above the set point is normally blocked. Used in the cases in which cooling is installed.

Extract air below alarm limit

Alarm limit for extract air temperature can be set. When the extract air temperature is below the alarm limit, alarm 12:6 is generated.

Outdoor temperature, stop limit

On tripped heat exchanger alarms, alarm numbers: 15:1-15:4, 16;1-16:4, 17:1, 17:4-17:9 (See the Manual for alarms and information messages), the following applies: if the outdoor air temperature is above this stop limit, an alarm only will be initiated and if it is below the stop limit, the AHU will stop and an alarm will be initiated.

Settings:

Value	Setting range	Factory setting
Pre-heat below set point	2 - 15 K	5.0 K
Supply air below set point	2 - 15 K	5.0 K
Supply air above set point	2 - 15 K	7.0 K
Extract air below alarm limit	-8 - +20 °C	12,0 °C
Outdoor temperature limit stop	-40 - +50 °C	5.0 °C

Temperature alarm limits

4.8.5 Service period

The air handling unit's service period can be set here. The remaining time to alarm can be read. An alarm will be initiated after the time interval has expired. If you reset the alarm in the alarm log, the alarm will trip again after 7 days. Following completed service, the alarm must always be reset in this menu and this will launch a new service interval.

Settings:

Value	Setting range	Factory setting
Service period	0 - 99 months	12 months

Service period

4.8.6 Alarm priority



Changes in alarm priority should only be made if you have special reasons for doing so and you should be aware of the consequences. The setting options are limited for some alarms with safety function.

Settings:

Value	Setting range
Alarm number	1:1 - 60:10
Active	On/Off
Priority	Info*/A/B
Air handling unit stop	On/Off

* Alarms are indicated as a flashing red LED on the hand-held terminal, no group alarm is forwarded.

Alarm priority

4.9 Log

An SD card must be fitted into the AHU's control card for the log function to work (2 GB SD cards are installed from the factory, 8 GB SD cards can be ordered as accessories).

4.9.1 Continuous log

The continuous log can be activated here. The login interval is one minute (1440 logins per 24-hour period). One login file is created for each 24-hour period.

Settings:

Value	Setting range	Factory settings
Log file period	On/Off	On

4.9.2 Log sender

The log function has a log sender function which can e-mail the log to an optional e-mail address and/or FTP address.

Settings:

Value	Setting range	Factory setting
Log sender active	On/Off	Off
Live mode	E-mail/FTP/E-mail and FTP	E-mail

Other settings can be entered in the AHU's web page.



4.10 Air handling unit

4.10.1 Settings

! Set the type of air handling unit here. The type of air handling unit is normally preset for the unit supplied; except the GOLD SD extract air unit which must be set here.

N.B.! Do not change the air handling unit setting to a type that differs from the one supplied. If you do so, the air handling unit will not operate satisfactorily.

The air handling unit can be given a specific name (e.g. the unit's serial number). Naming in the hand-held terminal can only be done with digits, however on the web page the naming can also be done with alphabetical characters. The given name is then shown in all the images in the hand-held terminal and web page.

The type of AHU, size of the supply air and extract air fan respectively can be viewed.

GOLD RX/PX/CX

The AHU's fan position 1 (left-hand fan seen from the inspection side, see illustrations) can be read and preset.

! N.B.!! This changes the function of the fans from supply air to extract air and vice versa. GOLD RX size 004-120/ GOLD RX Top can be changed at the site. The other variants must not be changed from the factory setting.

For changes in fan position, check the filter class in the supply and extract air. If the filter classes for the supply and extract air are not equal, change the positions of the filters. RX Top 004-012 and 025/030 has supply and extract air filters in different dimensions, these must be ordered. For RX Top 004-012 another commissioning plate must also be ordered.

The fan position in the flow chart can be read and should be set according to the AHU's actual configuration.

Fan position 1

GOLD RX 004-120

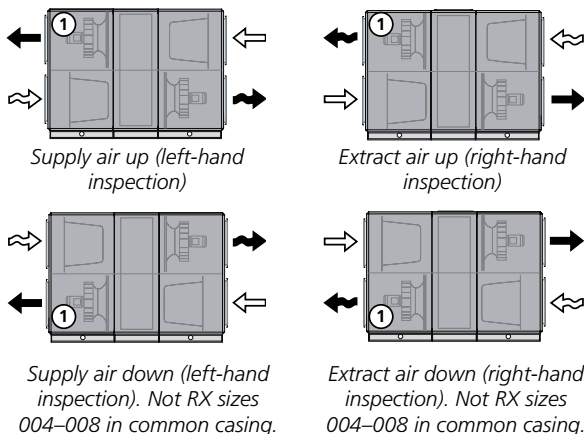

GOLD RX Top 004-012 (011/012 in combination with COOL DX Top)

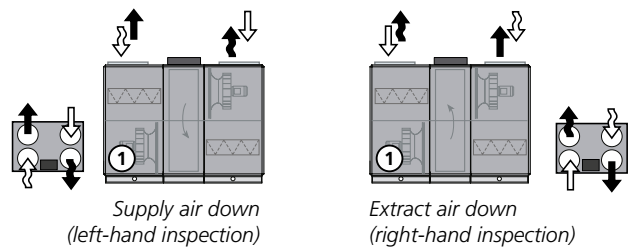

GOLD RX Top 011-012 (without COOL DX Top)

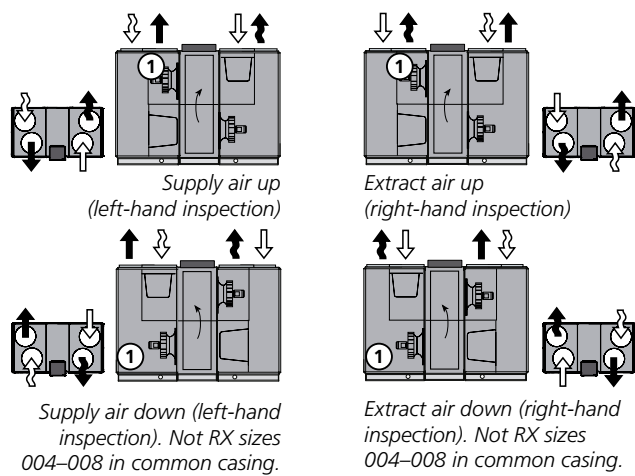

GOLD RX Top 014-030

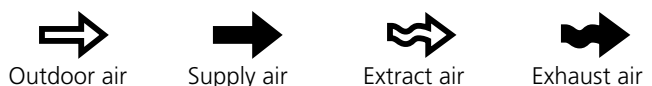
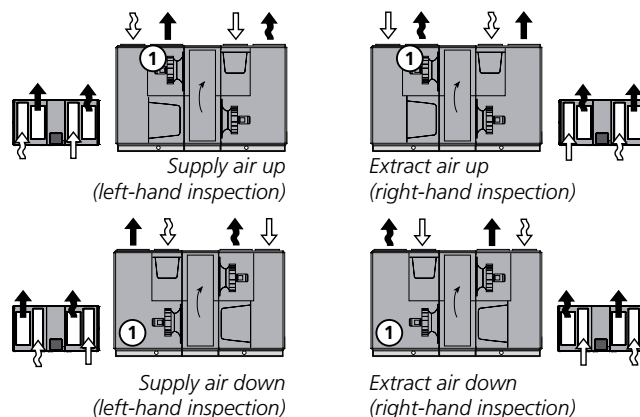

GOLD SD

The fan position, upper or lower level, can be read and should be set according to the AHU's actual configuration.

Settings:

Value	Setting range	Factory setting
Type of air handling unit	GOLD RX/GOLD PX/GOLD CX/ GOLD SD Supply air/GOLD SD Extract air/ GOLD SD Supply air+CX/ GOLD SD Supply air+Extract air/ GOLD SD Supply air+Extract air+CX	Type of air handling unit supplied, except the GOLD SD extract air handling unit
GOLD RX/PX/CX Name	Optional	
Fan position 1	Extract air/ Supply air	Extract air
Flow chart, supply air fan position	Upper level/ Lower level	Lower level
GOLD SD Name	Optional	
Flowchart fan position	Upper level/ Lower level	Lower level

4.10.2 Fan status

The fan control speed setting can be viewed in percent of max. speed here.

Fan status

4.10.3 Operation time

In operation times (in days) can if applicable be viewed for fan controls, heat exchanger/cooling recovery, preheating, extra heating regulation sequence, Xzone heating, AHU reheating, ReCO₂ heating, extra cooling regulation sequence, Xzone cooling, AHU cooling, ReCO₂ cooling, AYC heating water and AYC cooling water.

Operation time

4.10.4 VOC/CO₂ sensor

You can select here the operating mode for the VOC sensor and the CO₂ unit. The VOC level can be read. The VOC sensor position in the flow chart can be selected if only monitoring has been selected.

VOC/CO₂ sensor

Settings:

Value	Setting range	Factory setting
VOC sensor mode	Inactive/Monitoring only/Monitoring and regulation	Inactive
CO ₂ unit ¹⁾	%/ppm	% ¹⁾
Flow chart, VOC sensor position	Supply air/ Extract air	Supply air

¹⁾ Factory set values: 0% = 500 ppm, 50% = 1000 ppm, 100% = 1500 ppm

4.10.5 Automatic functions

Start up sequence

The air handling unit has a start up sequence with a factory-preset time delay between each step as follows:

1. The damper relay is energized and opens the shut-off damper (if installed). The heat exchanger is controlled to max. heat recovery (not the GOLD SD without heat exchanger). The valve for reheating opens to 40% (if installed)
Time delay: 30 seconds.
2. The extract air fan starts in the current operating mode (not for ventilation systems with GOLD SD supply air handling unit only)
Time delay: 60 seconds.
3. The supply air fan starts (not for ventilation systems with GOLD SD extract air handling unit only)
Time delay: 30 seconds.
4. The reheating function is ramped up or down depending on the heating load. Ramp time: 180 seconds. After that the heat exchanger is ramped up or down depending on the heating load. Ramp time: 180 seconds.

The entire start up sequence can be followed in the dashboard image.

The start up sequence prevents the extract air fan from starting up if the shut-off damper is closed. By first starting up the extract air fan and the heat exchanger, you can avoid chilling the premises with supply air on a start up under cold weather conditions.

Zero point calibration

The pressure sensor of the AHU is automatically calibrated. The calibration process takes about 70 seconds after the AHU has stopped (a notification is shown if the AHU has not stopped). The zero point calibration text is displayed in the hand-held terminal. The fans cannot start while calibration is in progress.

4.11 Heat

4.11.1 Status

All the relevant values can be read here. Used for performance checks.

4.11.2 Pre-heat

By preheating the outdoor air, it is possible to prevent moisture precipitation in the AHU's outdoor air filter, to reduce the risk of frosting in the heat exchanger and to eliminate the risk that pressure sensors and motor control systems are operating in too low ambient temperature.

Scope for setting Outdoor air temperature related preheat is available.

See also the Pre-heat function guide for more detailed information.

Settings:

Value	Setting range	Factory setting
Pre-heat	On/Off	Off
Pre-heat set point	-40 – +40°C	5°C
Outdoor air temperature related Difference, outdoor air temperature	0 – 25 K	5 K
Preheat, min. limit	-40 – +40 °C	-10 °C
Periodic operation of pump	On/Off	On
Periodic operation of valve	On/Off	On
Periodic operation interval	0-168 hrs.	24 hrs.
Periodic operation period	0-60 min.	3 min.
Alarm input, function	Inactive/Alarm on open contact/ Alarm on closed contact/Contactor function	Inactive

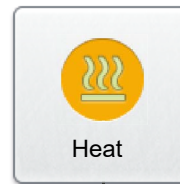

Status

Pre-heat

4.11.3 Extra regulation sequences 1 and 2

Used for extra regulation functions controlled by a 0-10 V (10-0 V) signal with ordinary temperature regulation sequence.

The function can be used for utilising existing heating or cooling sources, such as from a chiller. The function can also be used for an extra air heater or air cooler.

It can also be used for controlling dampers for recirculation, if required. In these cases, an inverted 10-0 V output is used.

Recirculation control is used for the TBBD mixing section (GOLD SD only) The 10-0 V inverted output should be in the On position.

The maximum output signal can be limited from 100% down to 0 %.

The output signal of the extra regulation sequence is controlled from the TBIQ-3-2 IQlogic+ module accessory, see separate installation instructions.

When the SMART Link DX function is selected, the extra regulation sequence is automatically activated. The extra regulation sequence cannot then be used for any other functionality. An IQlogic+ module is not required (alarm for missing module is blocked).

The extra regulation sequence makes it possible to control two air heaters at the same time in the following combinations: water - electricity, water - water, electricity - electricity (Season heat, see also Section 4.11.7). The air heater for hot water is available without or without frost guard function.

When the output of the first air heater is not sufficient, the second is automatically brought into the sequence.

A start-up sequence, frost guard function, pump control, post-cooling for electric air heater and other functionality are available.

For the start-up sequence, frost guard function, periodic operation and post-cooling, the same settings are used as for regular reheating.

Settings:

Value	Setting range	Factory setting
Extra regulation sequence 1/2	Inactive/Heat/Cool/Heat and cool	Inactive
Inverted output 10-0V	On/Off	Off
Recirculation control	On/Off	Off
Max. output signal	0-100%	100%
Periodic operation of pump	On/Off	On
Periodic operation of valve	On/Off	On
Periodic operation interval	0-168 hrs.	24 hrs.
Periodic operation period	0-60 min.	3 min.
Alarm input, function	Inactive/Alarm on open contact/Alarm on closed contact/Contactor function	Inactive

Extra regulation sequence 1/2

4.11.4 Extra regulation sequences 1 and 2, combi coils

The function is used to control combi coils (heating and cooling), see separate function guide for combi coils.

Extra regulation sequence 1/2, combi coils

Settings:

Value	Setting range	Factory settings
Combi coils, function	On/Off	Off
Temperature protection, function	On/Off	Off
Temperature protection, alarm delay	0 - 999 min.	5 min.
External signal, function	Inactive/Digital input/BMS	Inactive
External signal, indication	Heating/Cooling	Heating
Digital output, function	On/Off	Off
Digital output, indication	Heating/Cooling	Heating

4.11.5 Reheat

The air heater is equipped with a quick-fit connector for connection to the AHU's control unit which automatically senses the type of air heater in use.

Air heater for hot water

When there is a reheating load, and the function Periodic operation of pump or of pump+valve is selected, the relay output is activated (control unit terminals 20-21) and this starts the circulation pump of the air heater.

If the outdoor temperature is low (colder than +12 °C), the pump output contact is continuously activated. During other times, the pump output contact is activated 3 min./day (factory setting) for periodic operation the circulation pump.

Alarm inputs can be activated as alarm on open contact, alarm on closed contact or contactor function. Requires the accessory TBIQ-3-2, see the separate installation instructions.

Settings:

Value	Setting range	Factory setting
<i>Air heater for hot water</i>		
Periodic operation of pump	On/Off	On
Periodic operation of valve	On/Off	On
Periodic operation interval	0-168 hrs.	24 hrs.
Periodic operation period	0-60 min.	3 min.
Alarm input, function	Inactive/Alarm on open contact/Alarm on closed contact/Contactor function	Not active

Electric air heater

When there is a reheating load, the relay output is activated (control unit terminals 20-21).

The relay output can be used for indicating or blocking the external function.

Reheat

4.11.6 Xzone

The Xzone temperature control function is designed for controlling one extra temperature zone via the ventilation system.

Xzone can be used for all types of air handling units, and both reheating and cooling can be controlled in the extra zone.

See also the Xzone function guide for more detailed information.

Settings:

Value	Setting range	Factory setting
Xzone	On/Off	Off
<i>Air heater for hot water</i>		
Periodic operation of pump	On/Off	On
Periodic operation of valve	On/Off	On
Periodic operation interval	0-168 hrs.	24 hrs.
Periodic operation period	0-60 min.	3 min.
Alarm input, function	Inactive/Alarm on open contact/Alarm on closed contact/Contactor function	Inactive

Xzone

4.11.7 Electric air heater

If the electric air heater has been in operation, the air heater is post-cooled for about 3 minutes (factory setting) when stop has been activated.

The text "After cool" appears in the hand-held terminal.

Settings:

Value	Setting range	Factory setting
After cool	1 - 25 min	3 min.

Electric air heater

4.11.8 Season Heat

The Season Heat function involves that the extra regulation sequence 1 functions is activated. See Section 4.11.3.

When both the standard function for reheating and the extra heating sequence are activated, it is possible to alternate between these via a digital input or communication.

Example: Hot water is only available in the winter. In the summer, any reheating load is backed up by an electric air heater. Changeover can be done manually or via external thermostat, external clock function or the like.

Settings:

Value	Setting range	Factory setting
Season Heat	Inactive/Extra reg. seq. 1 closed contact/Extra reg. seq. 1 open contact/Extra reg. seq. 1 Manual ¹⁾	Inactive
Extra reg. seq. enabled (manual only)	On/Off ²⁾	Off

Season Heat

¹⁾ Extra regulation sequence 1 closed contact = When the contact is closed, only the standard reheating function is active. When the contact is opened a changeover to extra heating regulation sequence occurs.

Extra regulation sequence 1 open contact = When the contact is open, only the standard reheating function is active. When the contact is closed, a changeover to extra heating regulation sequence occurs.

Extra regulation sequence 1 Manual = Changeover is done in the hand-held terminal or on the AHU's web page.

²⁾ Extra regulation sequence in Off position involves that the standard function for reheating is active and in the On position a changeover to extra regulation sequence occurs.

4.11.9 Automatic functions

Frost guard function, air heater for water

The frost guard function is always active if the connected air heater for hot water has been supplied by Swegon.

The function activates a heating device that keeps the temperature in the coil at 13 °C while the air handling unit is operating and 25 °C in the coil when the unit is stopped. An alarm is initiated and stops the AHU if the temperature sensor senses a temperature below 7 °C.

Capacity reduction of the electric air heater

Only in combination with Swegon's electric air heater.

A min. permissible air velocity of 2.0 m/s is required for preventing the electric heating elements from becoming overheated when they are generating full heating output.

If the air handling unit supply airflow drops below the value that corresponds to an air velocity of 2.0 m/s across the heat exchanger, the heating output of the air heater will be automatically reduced.

4.12 Cool

4.12.1 Status

All the relevant values can be read here. Used for performance checks.

4.12.2 Extra regulation sequences 1 and 2

Used for extra regulation functions controlled by a 0-10 V (10-0 V) signal with ordinary temperature regulation sequence.

The function can be used for utilizing existing heating or cooling sources, such as from a chiller. The function can also be used for an extra air heater or air cooler.

It can also be used for controlling dampers for recirculation, if required. In these cases, an inverted 10-0 V output is used.

Recirculation control is used for the TBBD mixing section (GOLD SD only) The 10-0 V inverted output should be in the On position.

The maximum output signal can be limited from 100% down to 0 %.

The output signal of the extra regulation sequence is controlled from the TBIQ-3-2 IQlogic+ module accessory, see separate installation instructions.

When the SMART Link DX function is selected, the extra regulation sequence is automatically activated. The extra regulation sequence cannot then be used for any other functionality. An IQlogic+ module is not required (alarm for missing module is blocked).

Settings:

Value	Setting range	Factory setting
Extra regulation sequence 1/2	Inactive/Heat/Cool/Heat and cool	Inactive
Output inverse 10-0V	On/Off	Off
Recirculation control	On/Off	Off
Max. output signal	0-100%	100%
Periodic operation of pump	On/Off	On
Periodic operation of valve	On/Off	On
Periodic operation interval	0-168 hrs.	24 hrs.
Periodic operation period	0-60 min.	3 min.
Alarm input, function	Inactive/Alarm on open contact/Alarm on closed contact/Contactor function	Inactive



Status

Extra regulation sequence 1/2

4.12.3 Extra regulation sequences 1 and 2, combi coils

The function is used to control combi coils (heating and cooling), see separate function guide for combi coils.

Extra regulation sequence 1/2, combi coils

Settings:

Value	Setting * range	Factory settings
Combi coils, function	On/Off	Off
Temperature protection, function	On/Off	Off
Temperature protection, alarm delay	0 - 999 min.	5 min.
External signal, function	Inactive/Digital input/BMS	Inactive
External signal, indication	Heating/Cooling	Heating
Digital output, function	On/Off	Off
Digital output, indication	Heating/Cooling	Heating

4.12.4 Cool

The valve actuator of the air cooler for water is equipped with a quick-fit connector for connection to the AHU's control unit which automatically activates the cooling function.

Cool

1-step

Used if cooling in one step is connected. The cooling controller of the AHU regulates the cooling output according to the cooling load, 0-100 %. The cooling relay is energised when the cooling load exceeds 5 % and is de-energised when the cooling load is below 2 %.

2-step

Used when cooling in 2 steps is connected. The cooling controller of the AHU regulates the cooling output according to the cooling load, 0-100 %.

Cooling relay 1 is energised when the cooling load exceeds 5 % and is de-energised when the cooling load is less than 2 %. Cooling relay 2 is energised when the cooling load exceeds 55 % and is de-energised when the cooling load is less than 50 %.

3-step, binary

Used when cooling with two inputs controlled with three binary steps is connected. The cooling controller of the AHU regulates the cooling output according to the cooling load, 0-100 %.

On an increasing cooling load:

Cooling relay 1 is energised when the cooling load is above 5 % and is de-energised when the cooling load is between 40-70 %. Cooling relay 2 is energised when the cooling load is above 40 %. Cooling relay 1 is energised again (together with cooling relay 2) when the cooling load is above 70%.

On a decreasing cooling load:

Cooling relay 1 is deenergised when cooling load is below 60 %, it is energised again when cooling load is below 30 % and is de-energised again when cooling load is below 2 %. Cooling relay 2 is de-energised when cooling load is below 30 %.

Alarm inputs can be activated as alarm on open contact, alarm on closed contact or contactor function. Requires the accessory TBIQ-3-2, see the separate installation instructions.

Settings:

Value	Setting range	Factory setting
<i>DX air cooler</i>		
Cooling	Inactive/1 step/2 steps/3 steps, binary	Inactive
<i>Air cooler for water</i>		
Periodic operation of pump 1	On/Off	On
Periodic operation of pump 2	On/Off	On
Periodic operation of valve	On/Off	On
Periodic operation interval	0-168 hrs.	24 hrs.
Periodic operation period	0-60 min.	3 min.
Alarm input 1/2, function	Inactive/Alarm on open contact/Alarm on closed contact/Contactor function	Not active

4.12.5 Xzone

The Xzone temperature control function is designed for controlling one extra temperature zone via the ventilation system.

Xzone can be used for all types of air handling units, and both reheating and cooling can be controlled in the extra zone.

See also the Xzone function guide for more detailed information.

Settings:

Value	Setting range	Factory setting
<i>DX air cooler</i> Cooling	Inactive/1 step/2 steps/3 steps, binary	Inactive
<i>Air cooler for water</i> Periodic operation of pump 1	On/Off	On
Periodic operation of pump 2	On/Off	On
Periodic operation of valve	On/Off	On
Periodic operation interval	0-168 hrs.	24 hrs.
Periodic operation period	0-60 min.	3 min.
Alarm input 1, function	Inactive/Alarm on open contact/Alarm on closed contact/Contactor function	Inactive
Alarm input 2, function	Inactive/Alarm on open contact/Alarm on closed contact/Contactor function	Inactive

Xzone

4.12.6 COOL DX

COOL DX - Economy (without heat exchanger)

Used when the COOL DX chiller is connected. Both cooling relays of the air handling unit operate in parallel with the corresponding relay on the IQlogic+ module in the COOL DX chiller.

COOL DX - Comfort

Used when the COOL DX chiller is connected. The heat exchanger in the AHU operates in sequence with the cooling unit to even out the supply air temperature.

COOL DX Top

Used when the COOL DX Top chiller is connected. Both cooling relays of the air handling unit operate in parallel with the corresponding relay on the IQlogic+ module in the COOL DX chiller.

Settings:

Value	Setting range	Factory setting
COOL DX	Inactive/Economy/Comfort/COOL DX Top	Inactive

COOL DX

4.12.7 Delay time

Stop drying delay is the delay time between switching off and stop of the air handling unit. Used to dry out any moisture if cooling has been operational.

Restart time is computed from when the compressor starts until it is permitted to start again.

Step switch time is the time delay between two steps.

Stop/start time is computed from when the compressor stops until it is permitted to start again.

Settings:

Value	Setting range	Factory setting
Stop, drying delay	On/Off	Off
Stop, drying delay time	1-60 min.	3 min.
Restart time	0-20 min.	5 min.
Step switch time	0-15 min.	5 min.
Stop/start time	0-15 min.	5 min.

Delay time

4.12.8 Outdoor air limits

Provision is available for setting an outdoor temperature-related blocking function in 3 steps. If the outdoor temperature is below each step limit, the function of the cooling relays will be blocked. The function is used for preventing the relevant compressors from being switched on and off too many times.

Settings:

Value	Setting range	Factory setting
Step 1	0 - 30°C	15°C
Step 2	0 - 30°C	18°C
Step 3	0 - 30°C	20°C

Outdoor air limits

4.12.9 Airflow, limits

Cooling, 0-10 V:

The cooling function is blocked if the supply or extract airflows are lower than the preset limit.

If the airflow limit function is not of immediate interest, both flow limits are set to 0.

Cooling, On/Off:

The current airflow must exceed the preset airflow as a condition for the respective cooling step to be put into operation.

Settings:

Value	Setting range	Factory settings
<i>Cooling, 0-10 V</i> Supply air, 0-10 V	0 - Max. flow	25% of max. airflow for air handling unit
Extract air, 0-10 V	0 - Max. flow	25% of max. airflow for air handling unit
<i>Cooling, On/Off</i> Supply air, On/Off, step 1	0 - Max. flow	25% of max. airflow for air handling unit
Extract air, On/Off, step 1	0 - Max. flow	25% of max. airflow for air handling unit
Supply air, On/Off, step 2	0 - Max. flow	50% of max. airflow for air handling unit
Extract air, On/Off, step 2	0 - Max. flow	50% of max. airflow for air handling unit
Supply air, On/Off, step 3	0 - Max. flow	75% of max. airflow for air handling unit
Extract air, On/Off, step 3	0 - Max. flow	75% of max. airflow for air handling unit

Air flow limits

4.13 Heat/Cool recovery

4.13.1 Status

All the relevant values can be read here. Used for performance checks.

See below for designations of each PX sectional damper (counterflow heat exchanger):

Sectional damper 1 (farthest out) = 1A

Bypass damper (centre) = 2A

Sectional damper 2 (farthest in) = 3A



Status

4.13.2 Carry over control



If the fans are generating low airflows, the rotary heat exchanger is decelerated to an appropriate speed to ensure a correct purging airflow through the heat exchanger.

Settings:

Value	Setting range	Factory setting
Carry over control	On/Off	Off

Carry over control

4.13.3 Efficiency measurement

The efficiency measurement of heat exchangers for RX/PX/CX can be enabled here.

The function requires the accessory, efficiency measurement TBLZ-1-83 (see separate instruction), which contains three sensors. Two of the sensors measures humidity/temperature in the extract air and exhaust air, the third sensor measures the outdoor air temperature.

Measured values are specified under the humidity function.

Settings:

Value	Setting range	Factory setting
Efficiency measurement	On/Off	Off

Efficiency measurement

4.13.4 Defrost



In environments where the extract air can occasionally be humid, the defrosting function can be activated to protect the heat exchanger from frosting. The function continuously monitors the condition of the heat exchanger rotor to prevent it from becoming clogged due to condensate that has frozen inside the exchanger.

The function requires a separate pressure sensor (preset for heat exchanger defrosting) wired to the control unit inputs for external BUS communication and connected to the AHU pressure measurement tappings. See special installation instruction for the TBLZ-1-23-aa pressure sensor.

The pressure drop across the rotor must then be calibrated to establish a reference pressure drop for monitoring purposes. Calibration is put into effect by setting Calibration to the On position.

When the defrosting function is activated the pressure drop across the heat exchanger is continuously measured and the reading is compared with the calibration reading. If the pressure drop exceeds the preset limit value, a defrosting sequence is implemented in which the rotor speed is gradually ramped down (ramp time max. 4 minutes). The lowest permissible speed of the rotor is 0.5 rpm. During the defrosting process, the warm extract air thaws any possible ice that has formed on surfaces.

If defrosting reduces the speed to the min. speed 0.5 rpm for more than 2.5 h an alarm is generated.

Note that the heat exchanger performs less efficiently while defrosting is in progress and that the supply air temperature will also drop downstream of the heat exchanger.

Settings:

Value	Setting range	Factory setting
Defrost	On/Off	Off
Defrost limit value	30 - 100 Pa	50 Pa
Calibration	On/Off	Off

Defrost

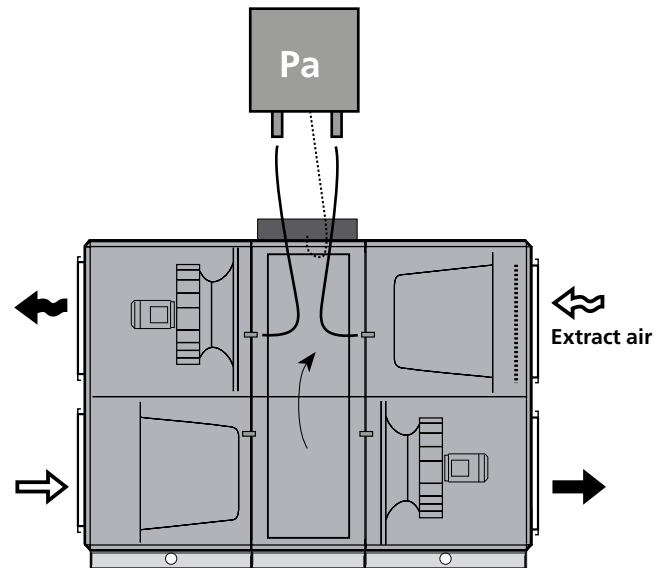

Connection principle for the defrosting function with separate pressure sensor.

4.13.5 Calibration/Optimization (GOLD PX)



Defrosting, Standard

Calibration should be carried out when the air handling unit is started up and when necessary. When calibration is in progress, the air handling unit's limit values for alarms and defrosting are calculated.

Defrosting, RECOFrost

Calibration should be carried out when the air handling unit is started up and when necessary. When calibration is in progress, the air handling unit's limit values for alarms and defrosting are calculated.

Bypass optimisation should be carried out when the air handling unit is started up and when necessary. When bypass optimization is in progress, the damper positions of the bypass are optimized.

Calibration and bypass optimization can be activated to occur at the same time or individually. If they are activated individually, whichever one is activated first is of no importance.

Settings:

Value	Setting range	Factory settings
Calibration	On/Off	Off
Bypass optimization (RECOFrost only)	On/Off	Off

4.13.6 Automatic functions

GOLD RX (rotary heat exchanger)

Purging function

Purging is an automatic function that prevents the rotary heat exchanger from standing still in the same position for a longer period when no heating is necessary.

Purging operation is activated when the AHU is operating but the heat exchanger rotor is not rotating. The heat exchanger rotor then rotates for 10 seconds every 10 minutes to purge its surfaces clean of impurities.

Calculation of the efficiency

The efficiency is calculated and displayed (0 – 100%).

Calculation of recovered energy

Recovered sensible energy is calculated and the values are displayed (instantaneous and accumulated).

Cooling recovery

Cooling recovery is an automatic function that helps the air handling unit on a cooling load and high outdoor air temperature to utilize the relative "cooling energy" that can be indoors. The heat exchanger rotates at max. speed and in this way recovers the relative cooling energy or chilliness in the extract air.

The conditions for this function to be activated are that there is a cooling demand and that the outdoor temperature is 1 °C higher than the extract air. The function stops when the cooling load ceases to exist or when the outdoor temperature is the same as that of the extract air.

Overtime heat exchanger operation

If the AHU stops, the heat exchanger automatically continues to recover heat for about 1 minute.

It takes a little time for the fans to stop rotating after a stop has been ordered and this prevents the supply air from chilling the premises.

Calibration/Optimization

GOLD CX/SD (coil heat exchanger)

Pump control, coil heat exchanger

The pump of the pipework package starts when heat recovery is needed. If heat recovery is not needed for more than 24 hours, the pump is exercised once a day.

Anti-frost protection

In cold weather, and if the extract air is humid, there is risk of frosting in the coil heat exchanger. The GOLD CX/SD is equipped with anti-frosting protection.

The temperature of the liquid circulated to the extract air coil and the humidity in the extract air are measured.

Taking the humidity into consideration, the control system calculates the lowest permissible temperature without risk of frosting inside the coil. The valve in the pipework package is then regulated to prevent the circulated liquid from dropping below this temperature.

GOLD PX (plate heat exchanger)

In cold weather, and when the extract air is humid, there is risk of frosting in the plate heat exchanger. The GOLD PX is therefore equipped with anti-frost protection.

Anti-frost protection, standard

The pressure drop across the heat exchanger and the outdoor air temperature are measured.

With consideration given to the pressure drop across the heat exchanger and the outdoor air temperature, the control system regulates dampers for bypass and heat exchanger (interlinked) in order to prevent the formation of frost.

RECOFrost anti-frost protection

The pressure drop across the heat exchanger, extract air temperature, moisture content in the extract air and outdoor air temperature are measured.

With consideration given to the pressure drop across the heat exchanger, the extract air temperature, the moisture content in the extract air and the outdoor air temperature, the control system individually regulates dampers for bypass and the heat exchanger for section-by-section defrosting without the formation of frost.

4.14 HC, reversible heat pump/chiller

The HC function is designed to control a reversible heat pump/chiller in the unit GOLD RX/HC.

For further information, see the GOLD RX/HC Function Guide.

Settings:

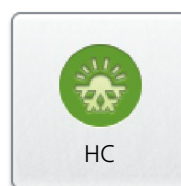

Value	Setting range	Factory settings
<i>Function</i>		
Position HC	On/Off	Off
HC defrosting accessories	Inactive/Recirculation/Electric air heater	Inactive
Heating function	Standard/Comfort	Comfort
Cooling function	Standard/Comfort	Comfort
Time for comfort mode	300 - 1800 s	900 s
<i>Outdoor temperature limits</i>		
Heating	-50 – +50 °C	-25 °C
Cool	0 – +50 °C	15 °C
<i>Air flow limits</i>		
Supply air	Min. flow* - Max. flow	40% of max. air flow for air handling unit
Extract air	Min. flow* - Max. flow	40% of max. air flow for air handling unit

*Min. flow for GOLD RX/HC, see the separate installation and maintenance instructions.

4.15 SMART Link

The SMART Link function is intended for use for optimum control of the temperature and operation as well as the reading of alarms and the values for a Swegon chiller/heat pump.

For more information concerning waterborne heat pumps chillers, see the Guide to the SMART Link/AQUA Link Functions.

For more information concerning DX heat pumps/chillers (Celest+ LE), see the Guide to the SMART Link DX (GOLD RX only) Functions.

Settings:



Value	Setting range	Factory setting
Type of unit	Inactive/ Water, heat pump/ Water, chiller/ Water, reversible/ DX, heat pump/ DX, chiller/ DX, reversible	Inactive
<i>Water</i>		
Heated water (set point)	10 - 80°C ¹⁾	40°C
Heated water, diff.	1 - 10 K	3 K
Chilled water (set point)	0 - 20°C ¹⁾	12°C
Chilled water, diff.	1 - 10 K	2 K
Outdoor air limit	-50 – +50°C	-20°C
(not applicable to the chiller)		
Optimize, heating	On/Off	Off
Optimize, cooling	On/Off	Off
Optimizing cooling regulation speed	0.01 - 6.00 K/min	0.3 K/min
Optimizing heating regulation speed	0.01 - 6.00 K/min	0.3 K/min
Valve limit, lower	5 - 90%	75
Valve limit, upper	70 - 100%	95
Delay	30 - 3200	60
AQUA Link	On/Off	Off
Pump alarm	Inactive/Alarm on closed contact/ Alarm on open contact/Contact function	Inactive
<i>DX</i>		
Number of connected units (Celest+)	1-4	1
Comfort mode heating, duration	0 - 180 min.	30 min.
Comfort mode cooling, duration	0 - 180 min.	30 min.
Outdoor air limit (not applicable to the chiller)	-50 – +50°C	-20°C
Defrost delay	5 - 900 s	180 s
Stabilization time	60 - 600 s	240 s
Supply air flow limit	²⁾ - 100% of max. air flow for air handling unit	50% of max. air flow for air handling unit

¹⁾ Min. and max. limited by preset values in the chiller/heat pump.

²⁾ Min. limited by set value in the chiller/heat pump.

4.16 Humidity

If the functions Dehumidifying regulation and Humidifying are activated at the same time, Dehumidifying regulation has priority and the possible settings for Humidifying are limited to being the same or lower than the setting for Dehumidifying regulation. There is a delay of 5 minutes between Dehumidifying regulation having stopped and Humidifying starting up (and vice versa).

4.16.1 Status

All the relevant values can be read here. Used for performance checks.

4.16.2 Humidifying

Evaporative humidification (On/Off)

This function is suitable together with an evaporative humidifier (not Swegon).

The function requires the TBIQ-3-1 IQlogic+ module accessory and one TBLZ-2-31-2 humidity sensor. See separate installation instructions. Install the humidity sensor in the extract air duct (or in the premises), see drawing.

The humidity in the extract air duct (the premises) is regulated between adjustable start and stop limits.

Steam humidification (0 - 10V)

The function is appropriate for operation together with a steam humidifier (not supplied by Swegon) and is a variable control system via 0-10 V control signal, as well as a contact function which interlocks the humidifier if the air handling unit stops, if Summer night cool is used or if the humidity in the supply air exceeds the set point by more than 10%.

The function requires the TBIQ-3-1 IQlogic Plus module accessory and one TBLZ-2-31-1 humidity sensor accessories (for supply air regulation) or two TBLZ-2-31-1/2 humidity sensor accessories (for extract air regulation), see separate installation instructions. Install the humidity sensors in the extract air duct and the supply air duct respectively. See drawing!

The function keeps the humidity level constant in the extract air duct (the premises) by regulating the humidity in the supply air. In order to prevent the humidity in the supply air from being too high, it is restricted to a maximum limit.

Alternatively the humidity in the supply air duct can be kept constant by selecting a regulating humidity sensor in the supply air.

The set point cannot be set higher than the max limit. If the dehumidification function is activated, the max limit cannot be set higher than the set point for dehumidification.

Settings:

Value	Setting range	Factory setting
Humidifying	Inactive/On/Off/ 0-10V	Inactive
Regulation sensor	Supply air/Extract air	Supply air
<i>Evaporative</i>		
Start	10 - 95%RH	40%RH
Stop	10 - 95%RH	45%RH
<i>Steam</i>		
Set point	10 - 95%RH	30%RH
Max. supply air	10 - 95%RH	80%RH

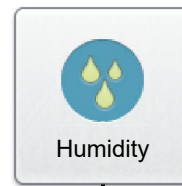

Status

Humidifying

Example, steam humidification

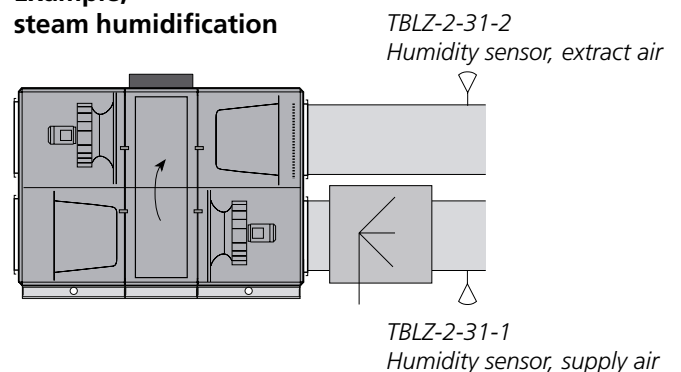

4.16.3 Dehumidifying

The function is intended for dehumidifying the supply air in order to prevent condensation in the supply air duct or in connected air conditioning products.

The dehumidification regulation function controls the humidity in the supply air duct or the extract air duct by means of an air cooler and an air heater for reheating.

The function requires that an air cooler be mounted upstream of the air heater in the supply air duct. See the example to the right.

If control of the humidity in the supply air duct is required, install a TBLZ-2-31-1 humidity sensor in the supply air duct. If control of the humidity in the extract air duct is required, install a TBLZ-2-31-2 humidity sensor in the extract air duct and a TBLZ-2-31-1 humidity sensor in the supply air duct. Connect the sensor to the AHU. See separate installation instructions.

Cooling energy is emitted to condense the moisture in the supply airflow, which then is heated to the desired supply air temperature. This causes a reduction in the moisture content of the supply air.

The cooling unit used must be sized so that the temperature of the supply air will be below the dew point, otherwise no condensation will arise and no dehumidification will occur.

Settings:

Value	Setting range	Factory settings
Dehumidification	Inactive/Supply air/Extract air	Inactive
Supply air - relative humidity	10-90%RH	50%RH
Extract air - relative humidity	10-90%RH	50%RH

4.16.4 Humidifier alarm

The alarm input can be selected to closed circuit, open circuit or contactor function.

Settings:

Value	Setting range	Factory setting
Alarm input	Inactive/Closed circuit/Open circuit/Contactor function ¹⁾	Inactive

¹⁾ Closed circuit involves closing the circuit in order to initiate an alarm. Open circuit involves opening the circuit in order to initiate an alarm. Contactor function involves the use of an auxiliary contact from a contactor, which controls the humidifier. The aux. contact is connected to the alarm input.

Dehumidifying

Example: Dehumidification regulation

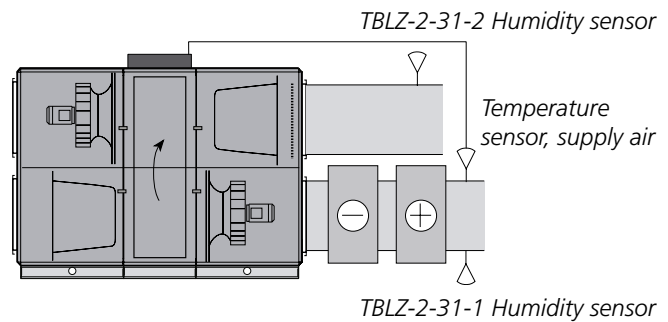

Humidifier alarm

4.17 ReCO₂

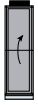

The ReCO₂ function is designed for ensuring the correct air quality or air temperature, by means of recirculating extract air and minimizing the inflow of outdoor air.

The function can be used in ventilation systems in which recirculated air intermixture is acceptable.

The function presupposes that the outdoor air damper and the damper in the air recirculation section are equipped with modulating damper actuators.

Lower outdoor air and exhaust air flows as well as lower extract air fan speed enable the unit to consume less power. A separate air quality sensor continuously measures the air quality of the ventilation system.

The pressure drop across the rotor must then be calibrated to establish a reference pressure for the function. Calibration is put into effect by setting Calibration to the On position.

For more information, see the ReCO₂ function guide.

Settings:

Value	Setting range	Factory setting
<i>Regulation mode</i>		
CO ₂ /VOC, operating mode	Inactive/CO ₂ /VOC / CO ₂ /VOC and air flow boost	Inactive
CO ₂ /VOC free cooling	On/Off	Off
Temperature mode	Inactive/Heat sequence/Cool sequence/Heat and cool sequence	Inactive
Temperature free cooling	On/Off	On
<i>CO₂/VOC</i>		
Set point	0 - 100%	50%
CO ₂ , set point	0 - 10000 ppm	1000 ppm
VOC, set point	0 - 10000 ppm	1500 ppm
Min. outdoor air	¹⁾	25% of max. airflow for air handling unit
Min. exhaust air	¹⁾	25% of max. airflow for air handling unit
<i>Calibration</i>		
Temperature	On/Off	Off
Min. outdoor air	¹⁾	25% of max. airflow for air handling unit
Min. exhaust air	¹⁾	25% of max. airflow for air handling unit
Calibration	On/Off	Off

¹⁾ The setting range is the same as the AHU's min. - max. settings.

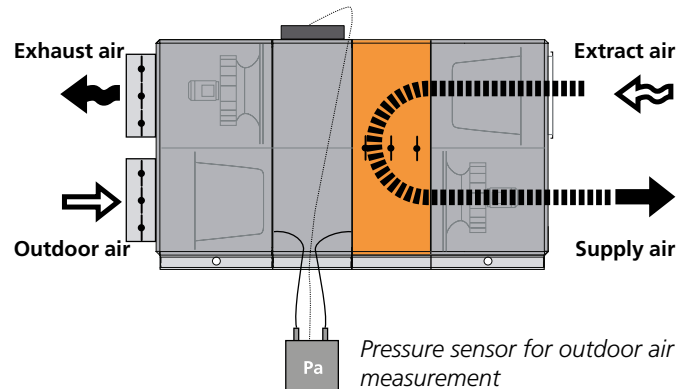
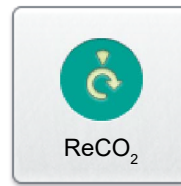

Outdoor airflow kept constant by pressure sensor

When the recirculation damper opens the extract air fan speed decreases and vice versa.

4.18 All Year Comfort

The All Year Comfort function controls, via control valves, the supply flow temperature to the comfort modules, cooling beams, perimeter wall units, etc. The water temperature is measured by two strap-on temperature sensors mounted on the water pipe of each circuit.

All Year Comfort has functions for outdoor compensation, room compensation, night compensation, dew point compensation as well as the monitoring and exercising of pumps and valves.

For more information, see the All Year Comfort function guide.

Settings:

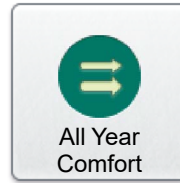

Value	Setting range	Factory setting			
Function	Inactive/Cooling water/Heating water/ Cooling water and heating water	Inactive	<i>Heated water</i> Heated water ¹⁾	10 - 80°C	30°C
			Outdoor temp compensation	On/Off	Off
			Outdoor temp X1	-40 - +40°C	-20°C
			Outdoor temp X2	-40 - +40°C	0°C
			Outdoor temp X3	-40 - +40°C	5°C
			Outdoor temp X4	-40 - +40°C	15°C
<i>Chilled water</i> Chilled water ¹⁾	5 - 30°C	14°C	Heated water temp Y1	10 - 80°C	40°C
Outdoor temp compensation	On/Off	Off	Heated water temp Y2	10 - 80°C	30°C
Outdoor temp X1	-40 - +40°C	10°C	Heated water temperature Y3	10 - 80°C	20°C
Outdoor temp X2	-40 - +40°C	20°C	Heated water temp Y4	10 - 80°C	15°C
Outdoor temp X3	-40 - +40°C	25°C	Outdoor temp for pump start	-40 - +40°C	15°C
Outdoor temp X4	-40 - +40°C	30°C	Outdoor temp for pump stop	-40 - +40°C	18°C
Chilled water temp Y1	5 - 30°C	22°C	Room temp compensation	On/Off	Off
Chilled water temp Y2	5 - 30°C	18°C	Room temp. set point	0 - 40°C	21°C
Chilled water temp Y3	5 - 30°C	14°C	Room temp. P-band	1 - 10 K	5 K
Chilled water temp Y4	5 - 30°C	12°C	Room comp. night block	On/Off	Off
Outdoor temp for pump start	-40 - +40°C	10°C	Night compensation	On/Off	Off
Outdoor temp for pump stop	-40 - +40°C	7°C	Night reduction	0 - -10 K	-2 K
Room temp compensation	On/Off	Off	Time channel 1/2 start of night	00:00 - 23:59	00:00
Room temp. set point	0 - 40°C	21°C	Time channel 1/2 end of night	00:00 - 23:59	00:00
Room temp. P-band	1 - 10 K	5 K	Time channel 1/2 period	Inactive/ Monday/ Tuesday/ Wednesday/ Thursday/Friday/ Saturday/Sunday Mon - Fri/Mon - Sun/ Sat - Sun	Inactive
Room comp. night block	On/Off	Off			
Night compensation	On/Off	Off	Air flow compensation	On/Off	Off
Night reduction	0 - 10 K	2 K	Periodic operation pump	On/Off	On
Time channel 1/2 start of night	00:00 - 23:59	00:00	Periodic operation valve exercising	On/Off	Off
Time channel 1/2 end of night	00:00 - 23:59	00:00	Periodic operation interval	0-168 hrs.	24 hrs.
Time channel 1/2 period	Inactive/ Monday/ Tuesday/ Wednesday/ Thursday/Friday/ Saturday/Sunday Mon - Fri/Mon - Sun/ Sat - Sun	Inactive	Periodic operation period	0-60 min.	3 min.
			Pump alarm	Inactive/Alarm on closed contact/Alarm on open contact/ Contactor function	Inactive
Dew point compensation	On/Off	Off	Valve alarm	On/Off	Off
Air flow compensation	On/Off	Off			
Periodic operation pump	On/Off	On			
Periodic operation valve exercising	On/Off	Off			
Periodic operation interval	0-168 hrs.	24 hrs.			
Periodic operation period	0-60 min.	3 min.			
Pump alarm	Inactive/Alarm on closed contact/Alarm on open contact/ Contactor function	Inactive			
Valve alarm	On/Off	Off			

¹⁾ Omitted if the outdoor temperature compensation is selected.

4.19 MIRU

4.19.1 Roof ventilator MIRUVENT, version MIRU-1 and -2

Up to ten power roof ventilators with MIRU Control equipment can be connected to one GOLD air handling unit by means of bus communication.

If one or several power roof ventilator(s) is/are stopped via the control panel on the corresponding MIRU Control, the power roof ventilator(s) cannot be started via the GOLD unit hand-held terminal.

The settings in the hand-held micro terminal of the GOLD unit override the settings in the MIRU Control's control panel.

It is possible in the hand-held micro terminal to select whether the power roof ventilator should be controlled in parallel with the GOLD unit, and whether it should follow the low-speed/high-speed operating modes of the air handling unit.

The balanced ventilation function can be used if the power roof ventilators are used for variable flow. It is then possible to select which power roof ventilator(s) is/are to be included in the function.

In the case of balanced extract air, all the airflows of the activated power roof ventilators are added together. The extract airflow in the GOLD unit is decreased by the corresponding volume. In this way the supply airflow will be the same as the total extract airflow and balanced ventilation will be achieved inside the building.

In the case of balanced supply air, all the airflows of the activated power roof ventilators are added together. The supply airflow in the GOLD unit is increased by the corresponding volume. In this way the supply airflow will be the same as the total extract airflow and balanced ventilation will be achieved inside the building.

The function presupposes that pressure sensors for flow measurement and possible pressure regulation are connected to MIRO Control.

All the time channels available in MIRU Control can be set separately for each connected power roof ventilator via the GOLD unit hand-held micro terminal. For a description of the function, see the separate Guide to the MIRU Control Functions.

Depending on the function selected in MIRU Control, it is possible to set the desired set point for pressure or flow, low speed and high speed, in the GOLD unit hand-held micro terminal. For a description of the function, see the separate Guide to the MIRU Control Functions.



Settings:

Value	Setting range	Factory setting
Quantity MIRUVENT-fans	0 - 10 pcs.	0
Fan numbers 1 – 10, function	Inactive/Parallel start/Parallel low speed/high speed/Parallel start and low speed/high speed	Inactive
Fan numbers 1 – 10, balance function	Inactive/Supply air/Extract air	Inactive
Fans 1 – 10 low speed	0 – 750 Pa	100
Fans 1 – 10 low speed	¹⁾ m ³ /s	0
Fans 1 – 10 high speed	0 – 750 Pa	200
Fans 1 – 10 high speed	¹⁾ m ³ /s	0
Fans 1 – 10, channel 1 – 4 action	Inactive Low speed, Mon., Low speed Tue., low speed Wed., etc. Low speed, Mon. – Fri. Low speed, Sat. – Sun. Low speed, Mon. – Sun. High speed Mon., High speed Tue., High speed Wed., etc. High speed, Mon. – Fri. High speed, Sat. – Sun. High speed, Mon. – Sun.	Inactive
Start time	00:00-00:00	00:00
Stop time	00:00-00:00	00:00

4.19.2 Roof ventilator MIRUVENT, version MIRU-3

The MIRU function can control up to three roof ventilators of the type MIRUVENT-3. All settings are made on the GOLD air handling unit's hand-held terminal.

MIRU has functions for operating levels, outdoor compensation, parallel function, balance function, control function and timer.

For further information, see the function guide MIRU.

Settings:



Value	Setting range	Factory setting			
Function (number of power roof ventilators)	0 -3 pcs.	0	Fans 1-3, control function	Air flow/Duct pressure/duct pressure and air flow measurement	Air flow
<i>Fans 1-3 operating mode</i>			Fans 1-3, size	²⁾	MIRU-3-25-28-1-1
Fans 1-3 low speed	0 – 750 Pa	100	Fans 1-3, duct 1-4 action	Inactive	Inactive
Fans 1-3 low speed	¹⁾ m ³ /s	30% of max. air flow		Low speed, Mon., Low speed Tue., low speed Wed., etc.	
Fans 1-3 high speed	0 – 750 Pa	200		Low speed, Mon. – Fri.	
Fans 1-3 high speed	¹⁾ m ³ /s	70% of max. air flow		Low speed, Sat. – Sun.	
Fans 1-3 max. speed	10-100%	100%		Low speed, Mon. – Sun.	
Fans 1-3 outdoor compensation function	Inactive/Low speed/High speed/Low speed and High speed	Inactive		High speed Mon., High speed Tue., High speed Wed., etc.	
X1, outdoor temp.	-50 – +50 °C	-20 °C		High speed, Mon. – Fri.	
X2, outdoor temp.	-50 – +50 °C	-10 °C		High speed, Sat. – Sun.	
X3, outdoor temp.	-50 – +50 °C	+10 °C		High speed, Mon. – Sun.	
X4, outdoor temp.	-50 – +50 °C	+20 °C			
<i>Flow</i>					
Y1, air flow set point	¹⁾	25% of max. air flow	Start time	00:00-00:00	00:00
Y2, air flow set point	¹⁾	25% of max. air flow	Stop time	00:00-00:00	00:00
Y3, air flow set point	¹⁾	25% of max. air flow			
Y4, air flow set point	¹⁾	25% of max. air flow			
<i>Pressure</i>					
Y1, pressure set point	20-750 Pa	100 Pa			
Y2, pressure set point	20-750 Pa	100 Pa			
Y3, pressure set point	20-750 Pa	100 Pa			
Y4, pressure set point	20-750 Pa	100 Pa			
Fans 1-3, function	Inactive/Parallel start/Parallel low speed/high speed/Parallel start and low speed/high speed	Inactive			
Fans 1-3, balance function	Inactive/Supply air/Extract air	Inactive			

¹⁾ See function guide MIRU.

²⁾ MIRU-3-25-28-1-1, MIRU-3-25-31-1-1, MIRU-3-35-35-1-1, MIRU-3-35-40-1-1, MIRU-3-35-45-1-1, MIRU-3-45-50-1-1, MIRU-3-45-56-1-1, MIRU-3-45-56-2-1, MIRU-3-56-63-1-1, MIRU-3-56-71-1-2, MIRU-3-71-80-1-2, MIRU-3-71-80-2-2, MIRU-3-71-90-1-2

4.20 Inputs/Outputs

Can for example be used if the air handling unit will be controlled/monitored via microprocessor substation or a PLC system. External operation module 3/6 requires the TBIQ-3-2 IQlogic+ module accessory; external communication module A/B/C requires the TBIQ-3-1 accessory. See separate installation instructions.

Settings:

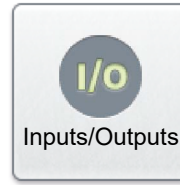

Value	Setting range	Factory setting
<i>External operation module 3/6</i>		
Digital output 1/2 mode	Inactive/Air handling unit in operation/Air handling unit in auto operation/ Air handling unit in manual operation/Air handling unit in low speed operation/Air handling unit in high speed operation/A alarm/B alarm/Damper relay/Heat exchanger/ Heat exchanger defrost/Reheat/ Reheating power reduction/Heating Boost/Morning Boost/Intermittent night heat/Airflow down regulation/ Extra reg. sequence 1 heat/Extra reg. sequence 1 cool/Cooling/Cooling Boost/Summer night cool/ Supply air fan in operation/Extract air fan in operation/Internal fire alarm tripped/ External fire alarm 1/External fire alarm 2/External fire alarm 1 or 2/Any fire alarm/External fire alarm 1 with priority/External fire alarm 2 with priority/Internal fire alarm tripped with priority/Preheating/HC defrosting/ HC defrosting with recirculation	Inactive
Digital input 1/2	Inactive/Alarm reset/Stop AYC heated water/Stop AYC chilled water/ MIRU 1-3 external stop/MIRU 1-3 external low speed/MIRU 1-3 external high speed/Reheating alarm input/Cooling alarm input 1/Cooling alarm input 2	Inactive
Analogue output 1	Indicates present supply airflow, from 0 to air handling unit's max. speed (%)	
Analogue output 2	Indicates present extract airflow, from 0 to air handling unit's max. speed (%)	
Analogue input 1/2*	Inactive/Set point displacement/Set point displacement, supply air/Set point displacement, extract air	Inactive
<i>External communication module A/B/C</i>		
External communication module A/B/C	On/Off	Off
Temperature sensor no. 1	On/Off	Off
Temperature sensor no. 2	On/Off	Off

* If analogue inputs 1 and 2 are both selected for setpoint displacement, only analogue input 1 will be used.

4.21 Communication



The potential for communication and monitoring is integrated as standard into the AHU. The AHU is ready to be connected via EIA-485. See Section 6.2 Wiring Terminal Connections in the Operating & Maintenance Instructions.

Communication can also be established via Ethernet without software other than an ordinary web browser such as Internet Explorer.

Further information about interfaces, protocols and configuration is available at www.swegon.se (com).

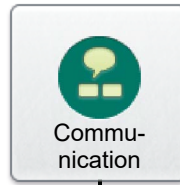

4.21.1 External Port B

For communication with network. Specify protocol and settings for Ethernet.

Settings:

Value	Setting range	Factory setting
DHCP	On/Off	Off
IP address (static or dynamic)		10.200.1.1
Net mask		255.255.255.0
Default GATEWAY		0.0.0.0
Primary DNS		0.0.0.0
Secondary DNS		0.0.0.0
MAC address		Not adjustable

4.21.2 Wireless LAN

The AHU's control unit is, as standard, equipped with Wi-Fi function and can be connected to e.g. a wireless hand-held terminal (accessory), portable computer or smart phone.

The password can, via the hand-held terminal, be changed to an optional combination of digits. The password and the SSID can also be entered in alphabetical form on the AHU's web page.

To connect to a portable computer or smart phone, note the settings on SSID, password and IP address. Activate Wi-Fi in the portable computer or smart phone and search for the wireless network (with the same name as the SSID). Connect by entering the password.

Open your web browser and update the page. The web browser will then automatically connect to the control circuit card. To log on, write your user name (local or installation), and enter the password (local = 0000, installation = 1111, factory setting).

Settings:

Value	Setting range	Factory setting
Wireless LAN	On/Off	Off
SSID	Optional	GOLD
Password (WPA2-PSK)	¹⁾	123456789
IP address	Not adjustable	169.254.233.1
Net mask	Not adjustable	255.255.255.0
MAC address	Not adjustable	Not adjustable
Channel (frequency band)	5 - 11	5

¹⁾ Certain smart phones require at least six characters.

4.21.3 E-mail

You can select whether the AHU shall handle outgoing e-mail here.

The settings can be entered on the AHU web page. See separate instructions.

There is a button for test transmission.

Settings:

Value	Setting range	Factory setting
SMTP server	External/Internal	External
SMTP server	Optional address	
SMTP port number		25
SMTP username	Optional, to be entered on the web page	
SMTP password	Optional, to be entered on the web page	
Encryption	On/Off	Off
E-mail sender	Optional, to be entered on the web page	
E-mail reply path	Optional, to be entered on the web page	

E-mail

4.21.4 EIA-485

Specify protocol and settings for EIA-485.

Settings:

Value	Setting range	Factory setting
Protocol	Inactive/Modbus/EXOline/ Metasys N2 Open/LON	Modbus
Baud rate	4800/9600/19200/38400	9600
Parity	None/Even/Odd	None
Stopbits	1/2	2
Modbus ID/ Metasys ID/PLA	1 - 247	1
ELA	1-255	1
Shortest feedback delay	0 - 100 ms	0 ms

EIA-485

4.21.5 Modbus TCP

Specify settings for Modbus TCP.

Settings:

Value	Factory setting
Port number	502
Approved client IP address	0.0.0.0
Approved client netmask	0.0.0.0

Modbus TCP

4.21.6 BACnet IP

Enter the BACnet IP settings.

Settings:

Value	Factory setting
Network number Ext. B	0
Internal network number A	0
Device ID	0
Port number	47808

BACnet IP

4.21.7 EXOline TCP

EXOline can be activated and enter the port number.

Settings:

Value	Setting range	Factory setting
Port number		26486
PLA	1 - 247	1
ELA	1-255	1



4.21.8 Operation level communication

It is possible to change the operation level communication here.

Settings:

Value	Setting range	Factory setting
Operation level communication	Inactive/Total stop/Low speed/High speed/Normal stop/ Extended normal stop	Inactive



4.22 Base setting

Used for saving, loading and restoring the settings.

A commissioning protocol can be created via the air handling unit's webpage as well as a pdf document once installation of the air handling unit has been completed. See the separate instruction for the air handling unit's webpage.

Date and time for the latest saved backup copy can be viewed.

The AHU's settings/communication settings are saved/loaded to/from the control unit's internal memory or external SD circuit card that can be inserted into the control unit.

The AHU settings involve all settings except communication settings.

Communication settings involve all settings (except AHU settings).

Settings:

Value	Alternative
<i>Air handling settings</i>	
Export air handling settings	Export to local backup/Export to SD card
Import air handling settings	Import from local backup/Import from SD card
<i>Communication settings</i>	
Export communication settings	Export to local backup/Export to SD card
Import communication settings	Import from local backup/Import from SD card

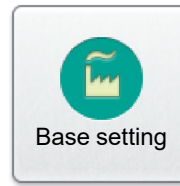

4.23 Users

The requirements for password can be activated here under User level (local). The password is always 0000.

Settings:

Value	Setting range	Factory setting
Requirements for user password	On/Off	Off

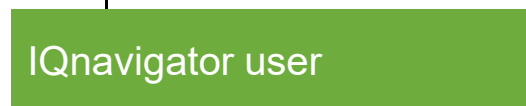
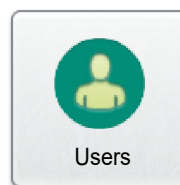

4.24 Notes

Notes can be read here. Notes can only be written on the AHU's web page.

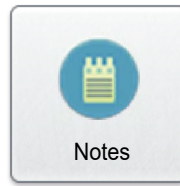

4.25 Manual test

 NB! Manual test running can cause indoor comfort problems. There is also risk of overloading the system. The responsibility for discomfort and overload rests totally on the person who activates the function.

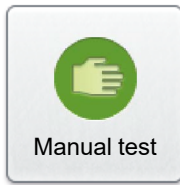

When you enter manual test, select safe mode or operating mode. Safe mode involves stopping the AHU and being able to run each installed function separately or together. Operating mode involves permitting the AHU to continue to operate in the normal operating mode and installed functions can be influenced manually.

Manual test operation can take place for testing the inputs and outputs, fans and heat exchanger, etc.

Used for installation or troubleshooting to test that wired connections and functions operate correctly.

Certain alarms, functions and normal control modes will be blocked while manual testing is in progress.

Each image indicates which functions can be test run.

4.26 IQnavigator (hand-held terminal)

4.26.1 Connect to IQlogic

The method of connection between the IQnavigator and IQlogic can be selected here.

Can be selected as direct (standard cable), DHCP or static IP (requires connection to network), and direct/wireless (requires the IQnavigator hand-held terminal with WLAN TBLZ-1-71-2 accessory. See separate instructions).

If the hand-held terminal is placed at a distance so that the standard cable between the hand-held terminal and control unit is not sufficient, the mains adapter TBLZ-1-70, available as an accessory, is required to power the hand-held terminal.

Settings:

Value	Setting range	Factory setting
Connect to IQlogic	Direct/DHCP/Static IP/ Direct/Wireless	Direct
IQnavigator IP address	Optional	
IQnavigator Netmask	Optional	
Pre-selected	Optional	
IQnavigator gateway		
IQlogic IP address	Optional	



Connect to IQlogic

4.26.2 Backlight brightness

The hand-held terminal can be set to four different backlight brightness settings.

Settings:

Value	Setting range	Factory setting
Brightness mode	Auto adjust/Low/ Medium/High	Auto adjust

Brightness mode

4.26.3 Acoustics

Button sound effects on the hand-held terminal can be activated and the volume can be set in five steps.

Settings:

Value	Setting range	Factory settings
Button sound effects	On/Off	Off
Volume	1-5	3

Acoustics

