

CDK/CKP

Circular ceiling diffuser for supply air - Conical upper section



QUICK FACTS

- Spread pattern can be shielded
- Handles large airflows
- Cleanable
- Adjustable slot
- Aerodynamically shaped inlet cone
- Non-perforated diffuser face = CDK
- Perforated diffuser face = CKP
- Standard colour White RAL 9003
 - 5 alternative standard colours
 - Other colours upon request

AIR FLOW - SOUND PRESSURE ROOM (Lp10A) *)							
CDK (CKP) Size		25 dB(A)		30 dB(A)		35 dB(A)	
		l/s	m ³ /h	l/s	m ³ /h	l/s	m ³ /h
100		47 (40)	169 (144)	55 (48)	198 (173)	65 (58)	234 (209)
125		75 (70)	270 (252)	88 (80)	317 (288)	105 (95)	378 (342)
160		125 (115)	450 (414)	145 (130)	522 (468)	175 (150)	630 (540)
200		190 (175)	684 (630)	235 (205)	846 (738)	280 (240)	1008 (864)
250		240 (250)	864 (900)	275 (300)	990 (1080)	325 (350)	1170 (1260)
315		275 (310)	990 (1116)	320 (360)	1152 (1296)	370 (410)	1332 (1476)
CDK (CKP) Size	ALS Size	25 dB(A)		30 dB(A)		35 dB(A)	
		l/s	m ³ /h	l/s	m ³ /h	l/s	m ³ /h
100	80-100	18 (17)	65 (61)	33 (30)	119 (108)	38 (35)	134 (126)
125	100-125	30 (28)	108 (101)	50 (40)	180 (144)	60 (52)	216 (187)
160	125-160	50 (46)	180 (166)	80 (65)	288 (234)	95 (85)	342 (306)
200	160-200	77 (72)	277 (259)	115 (92)	558 (331)	145 (130)	522 (468)
250	200-250	120 (100)	432 (360)	160 (130)	576 (468)	215 (160)	774 (576)
315	250-315	175 (155)	630 (558)	225 (180)	810 (648)	300 (225)	1080 (810)

Data applies to 360° spread pattern. Data for combination with ALS commissioning box is stated for a total pressure drop of 50 Pa. Values in brackets are for CKP.

*) Lp10A = Sound pressure incl. A-filter with 4 dB room attenuation and 10 m² room absorption area.

Contents

Technical description 3

- Design 3
- Materials and surface treatment..... 3
- Accessories 3
- Project planning..... 3
- Installation 3
- Commissioning with ALS 3
- Maintenance..... 3

Sizing 3

- CDK – Supply air 4
- CKP – Supply air 4
- CDK – Supply air 5
- CKP – Supply air 5
- CDK med ALS – Tilluft 6
- CKP with ALS – Supply air..... 7
- Shielding off the spread pattern..... 8

Dimensions and weights..... 9

Ordering key 10

Specification example 10

Technical description

Design

The CDK and CKP consists of two parts: an aerodynamically shaped upper section with a connection spigot have including a rubber sealing ring, and a removable non-perforated diffuser face. Between the upper cone and the diffuser face there is a slot which can be adjusted in two positions. The diffuser face of the CDK is non-perforated and on CKP it is perforated. Both CDK and CKP are equipped with acoustic insulation.

Materials and surface treatment

The upper part is manufactured in galvanized sheet steel. The diffuser face is made of sheet steel. The whole diffuser is painted inside and out.

- Standard colour:
 - White semi-gloss, lustre 40, RAL 9003/NCS S 0500-N
- Alternative standard colours:
 - Silver gloss, lustre 80, RAL 9006
 - Grey aluminium gloss, lustre 80, RAL 9007
 - Blanc semi-brillant, lustre 40, RAL 9010
 - Black semi-gloss, lustre 35, RAL 9005
 - Grey semi-gloss, lustre 30, RAL 7037
- Non-painted finish and other colours available on request.

Accessories

Commissioning box:

ALS made of galvanized sheet steel. Includes removable commissioning damper, fixed measurement unit and acoustic insulation with a reinforced surface layer, to Fire Resistance Class B-s1,d0 according to EN ISO 11925-2. Tightness class C on the housing according to SS-EN 12237.

Frame:

SAR C. For the aesthetic installation with lowered diffuser.

Sector shielding:

SAV. To shield the spread pattern.

Project planning

The diffuser has an aerodynamically shaped inlet spigot, which means that it can handle extremely large airflows at low sound levels.

Installation

The inlet spigot of the diffuser is fixed to the connecting duct with blind rivets. The diffuser face is removed by turning the springs which grip the pins of the diffuser face through $\frac{1}{4}$ turn (see Figure 1). When the ALS commissioning box is used, the spigot between the ALS and the CDK can be extended using normal circular duct up to 500 mm long without needing to extend either the measurement tubes or the damper cords. See Figure 1.

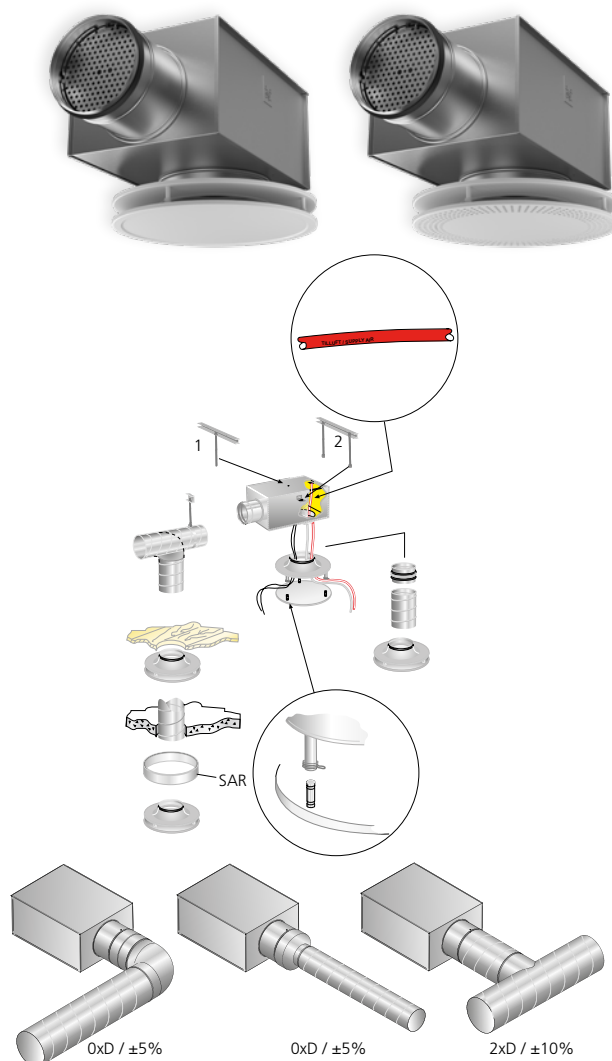

Figure 1. Installation.

Commissioning with ALS

This must be carried out with the diffuser face in place. The measurement tubes and the damper cords are pulled out of the diffuser through the slots. The damper setting is lockable.

Measurement accuracy and requirement on straight duct before the commissioning box, see Figure 1. The requirements of straight duct depends on the type of disturbance before the commissioning box. Figure 1 shows a bend, a dimensional change and a T-piece. Other types of disturbances requires at least $2xD$ straight ($D =$ connection dimension) for measurement accuracy of $\pm 10\%$ of the flow.

The k-factor is stated on the product label, and is also in the relevant k-factor guide which can be accessed at www.swegon.com.

Maintenance

The diffuser can be cleaned when necessary using luke warm water with added detergent. The duct system can be accessed without the use of tools. The spreader plate is removed by turning the springs which grip the pins through $\frac{1}{4}$ turn. If the commissioning box ALS is used, move the diffusion plate aside and the damper unit can then be removed by unscrewing it from its fastening.

Sizing

- Sound level dB(A) applies to rooms of 10 m² equivalent absorption area
- The throw $l_{0,2}$ is measured under isothermal flow conditions
- Recommended maximal under temperature is 10 K.
- All technical data applies to the following slot widths:
20 mm for sizes 100 and 125
30 mm for sizes 160, 200, 250 and 315.

- The slot widths can be increased to:
30 mm for sizes 100 and 125
40 mm for sizes 160, 200, 250 and 315.
This increase in slot widths cause reductions in throw, pressure drop and sound levels with ca 20%.
- For calculating the width of the air stream, air velocities in the occupied zone or sound levels in rooms with other dimensions, please refer to our web calculation softwares available for download at www.swegon.com
- All the technical data applies to a 360° spread pattern.

Sound data

CDK – Supply air

Sound power level L_w (dB)

Table K_{OK}

Size	Mid-frequency (octave band) Hz							
	63	125	250	500	1000	2000	4000	8000
CDK	63	125	250	500	1000	2000	4000	8000
100	10	14	3	-1	-2	-6	-18	-26
125	10	12	2	-1	-2	-4	-14	-25
160	9	11	2	-1	-1	-3	-17	-27
200	11	7	3	-2	0	-3	-14	-25
250	13	10	7	2	-2	-8	-23	-31
315	14	11	9	0	-7	-12	-27	-32
Size	Mid-frequency (octave band) Hz							
CDK + ALS	63	125	250	500	1000	2000	4000	8000
100	11	14	7	-1	-2	-11	-15	-21
125	10	13	8	-2	-4	-8	-17	-22
160	10	14	7	0	-6	-7	-16	-21
200	9	12	4	-2	-5	-5	-15	-18
250	10	14	5	-2	-5	-6	-16	-20
315	9	14	6	0	-4	-8	-15	-20
Tol. ±	2	2	2	2	2	2	2	2

Sound attenuation ΔL (dB)

Table ΔL

Size	Mid-frequency (octave band) Hz							
	63	125	250	500	1000	2000	4000	8000
CDK	63	125	250	500	1000	2000	4000	8000
100	22	17	14	9	6	5	8	9
125	21	17	12	7	5	5	9	9
160	20	14	10	5	6	5	10	9
200	18	14	9	7	5	5	10	9
250	17	11	8	8	5	7	12	10
315	17	11	9	9	6	11	13	10
Size	Mid-frequency (octave band) Hz							
CDK + ALS	63	125	250	500	1000	2000	4000	8000
100	18	14	17	18	25	21	20	20
125	20	15	15	19	24	19	20	19
160	20	14	10	17	19	12	10	12
200	16	12	14	19	21	17	20	18
250	18	11	13	20	19	17	20	18
315	13	6	12	21	18	18	21	19
Tol. ±	2	2	2	2	2	2	2	2

CKP – Supply air

Sound power level L_w (dB)

Table K_{OK}

Size	Mid-frequency (octave band) Hz							
	63	125	250	500	1000	2000	4000	8000
CKP	63	125	250	500	1000	2000	4000	8000
100	10	10	2	0	1	-8	-22	-30
125	10	10	3	0	0	-8	-21	-28
160	9	6	1	0	0	-4	-15	-27
200	11	6	1	1	1	-5	-20	-28
250	13	7	2	1	1	-8	-24	-31
315	14	5	2	2	1	-8	-24	-31
Size	Mid-frequency (octave band) Hz							
CKP + ALS	63	125	250	500	1000	2000	4000	8000
100	11	13	6	-1	-3	-10	-14	-21
125	10	12	7	-1	-4	-7	-17	-21
160	10	13	7	-1	-4	-7	-17	-20
200	9	10	4	0	-4	-7	-17	-19
250	10	11	4	1	-3	-8	-18	-20
315	9	9	3	4	-2	-10	-22	-24
Tol. ±	2	2	2	2	2	2	2	2

Sound attenuation ΔL (dB)

Table ΔL

Size	Mid-frequency (octave band) Hz							
	63	125	250	500	1000	2000	4000	8000
CKP	63	125	250	500	1000	2000	4000	8000
100	22	18	13	8	2	1	2	3
125	21	17	12	6	1	1	2	2
160	20	14	10	5	2	1	2	4
200	18	13	9	4	2	1	2	3
250	17	11	7	4	2	2	3	3
315	17	10	5	4	1	3	3	4
Size	Mid-frequency (octave band) Hz							
CKP + ALS	63	125	250	500	1000	2000	4000	8000
100	18	14	16	17	23	17	14	14
125	20	15	14	18	21	14	13	15
160	20	15	12	17	20	14	13	16
200	16	12	13	19	18	14	14	15
250	18	10	11	19	15	12	14	14
315	13	6	7	19	14	10	10	13
Tol. ±	2	2	2	2	2	2	2	2

Engineering graphs

CDK, CKP with and without ALS

Air flow - Pressure drop - Sound level - Throw

- The graphs apply to a CDK/CKP installed in a ceiling.
- The graphs are not to be used for commissioning.
- The dB(A) values are for rooms with normal acoustic absorption of 4 dB.
- The dB(C) value is normally 6-9 dB higher than the dB(A) value.
- Correction factor for shielded spread pattern, see graphs and examples below the dimensioning graph. Also see figure 2.

CDK/CKP – Supply air

Air diffuser only

CDK 100, 125, 160

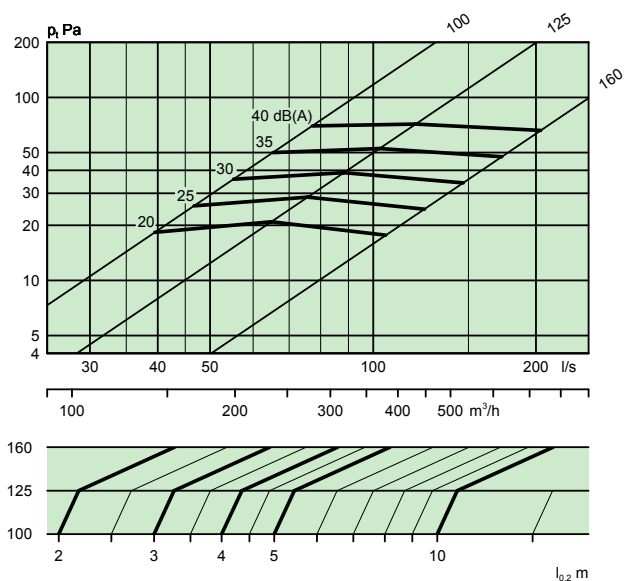

CDK 200, 250, 315

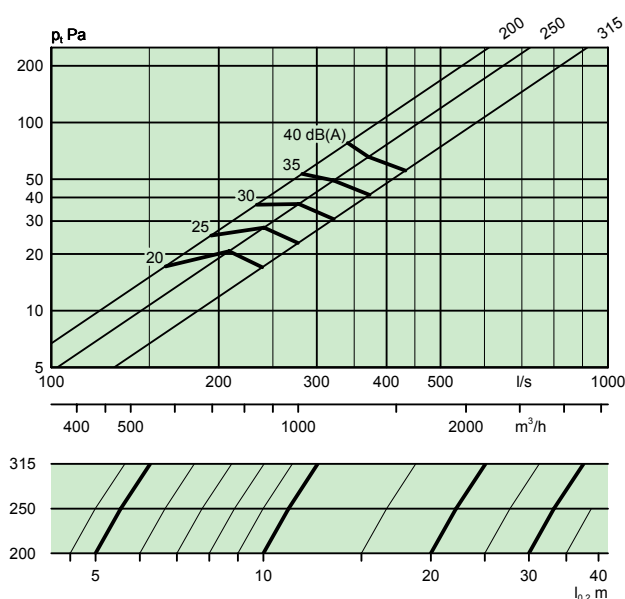

CKP 100, 125, 160

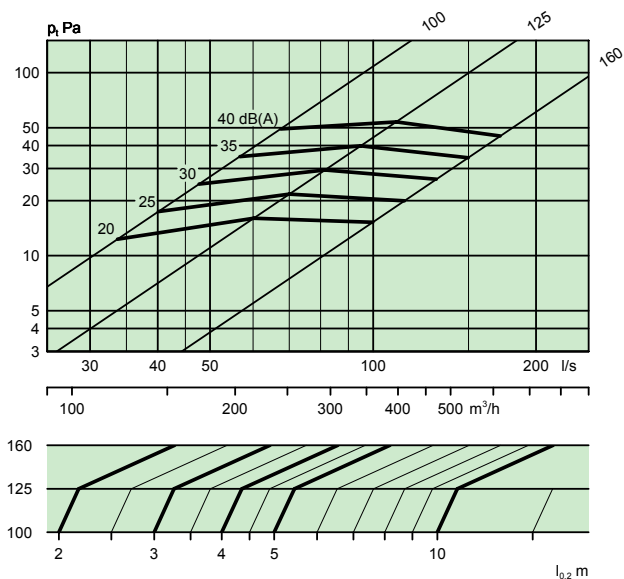

CKP 200, 250, 315

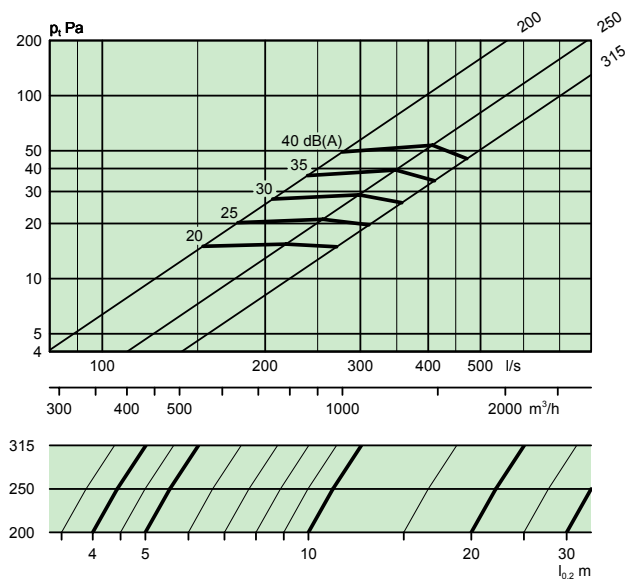

CDK with ALS – Supply air

Air diffuser with commissioning box

- Δ = the minimum flow required to obtain sufficient commissioning pressure.

CDK 100 + ALS 80-100

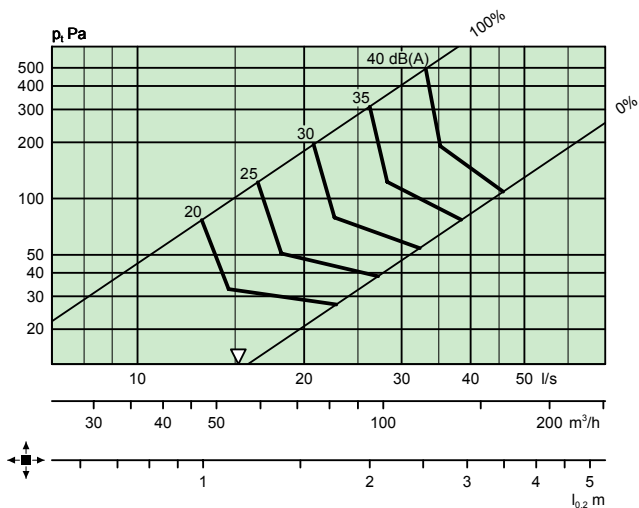

CDK 125 + ALS 100-125

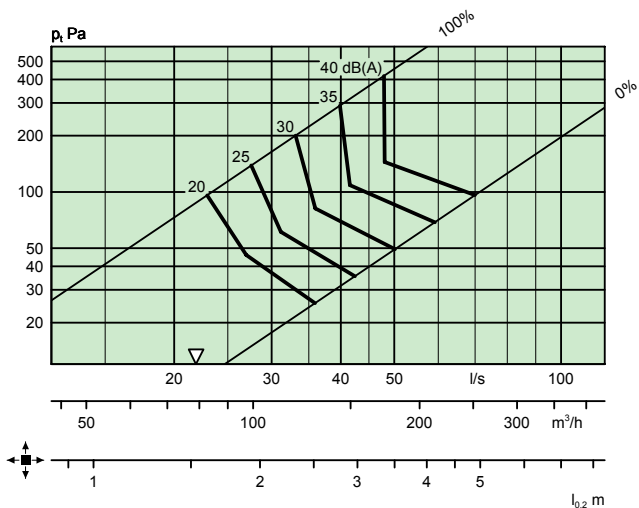

CDK 160 + ALS 125-160

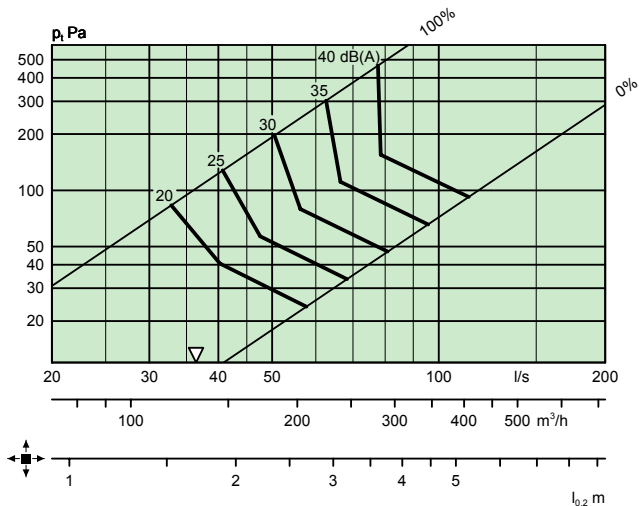

CDK 200 + ALS 160-200

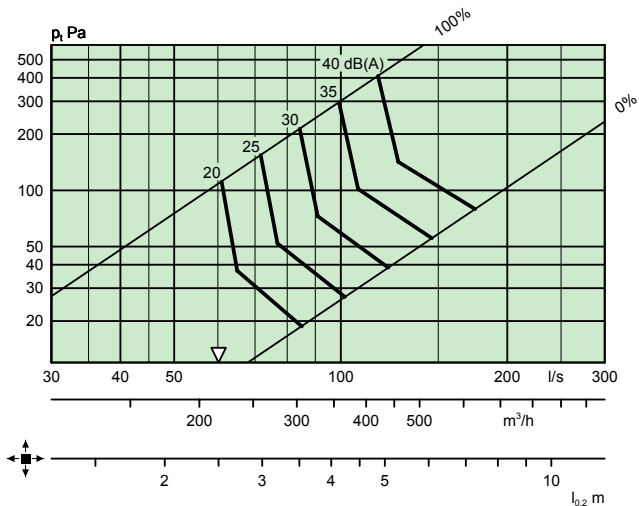

CDK 250 + ALS 200-250

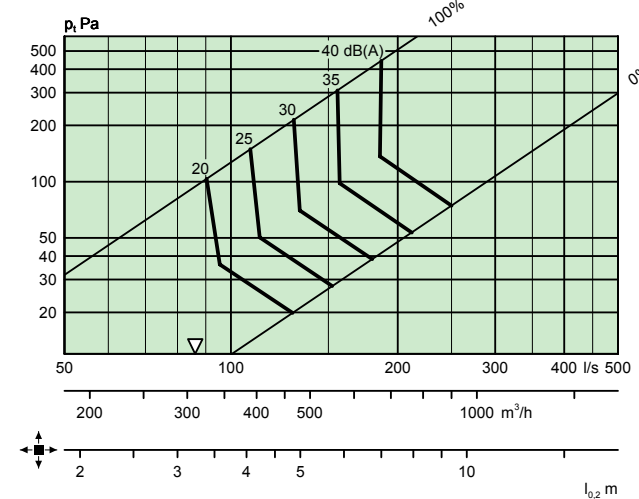

CDK 315 + ALS 250-315

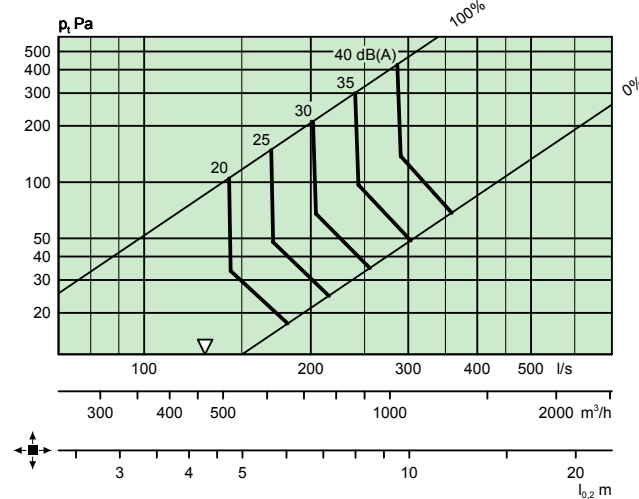

CKP with ALS – Supply air

Air diffuser with commissioning box

- Δ = the minimum flow required to obtain sufficient commissioning pressure.

CKP 100 + ALS 80-100

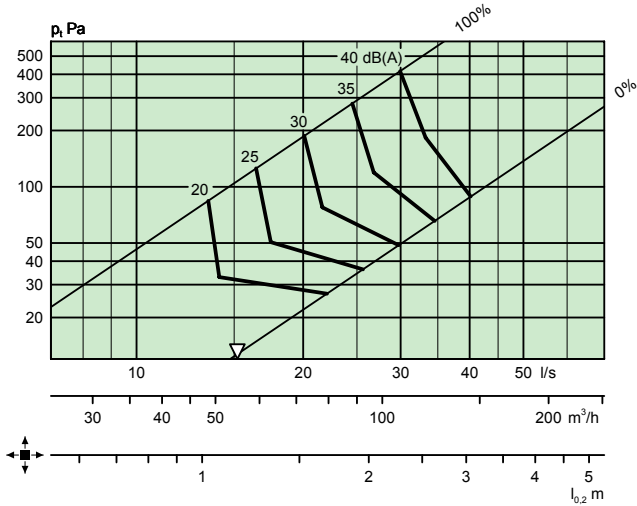

CKP 125 + ALS 100-125

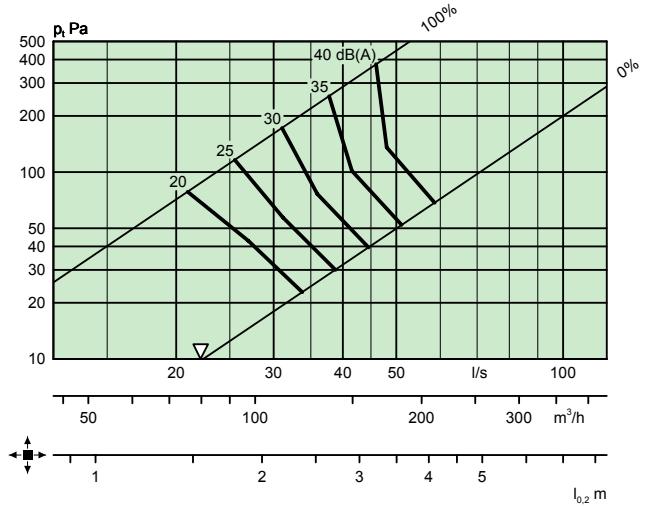

CKP 160 + ALS 125-160

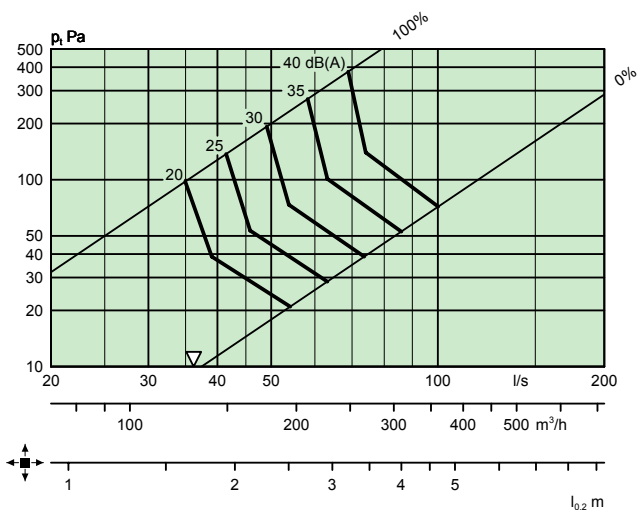

CKP 200 + ALS 160-200

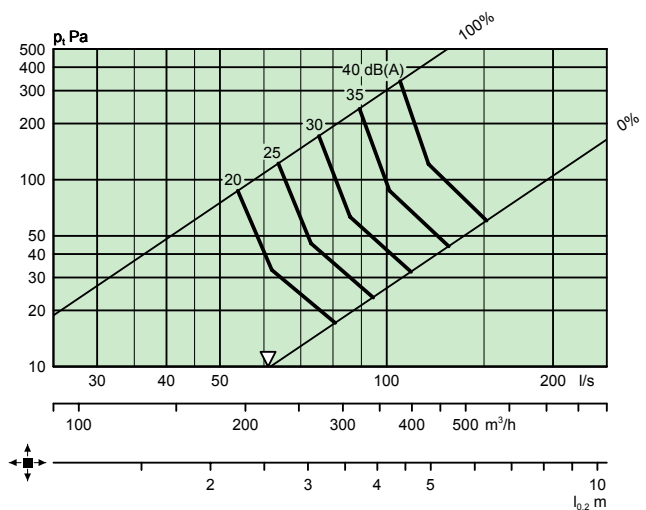

CKP 250 + ALS 200-250

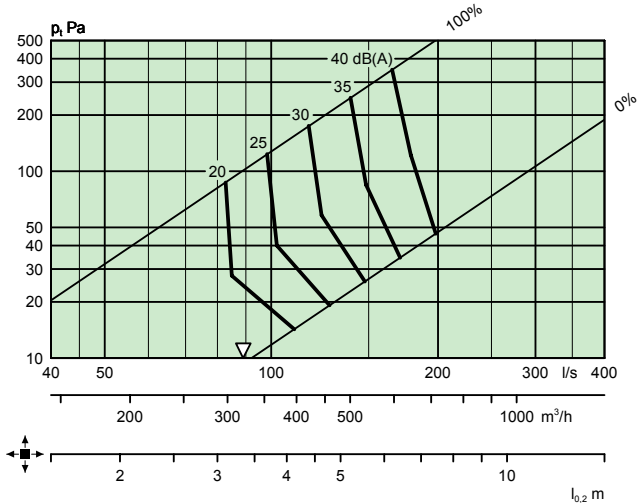

CKP 315-ALS 250-315

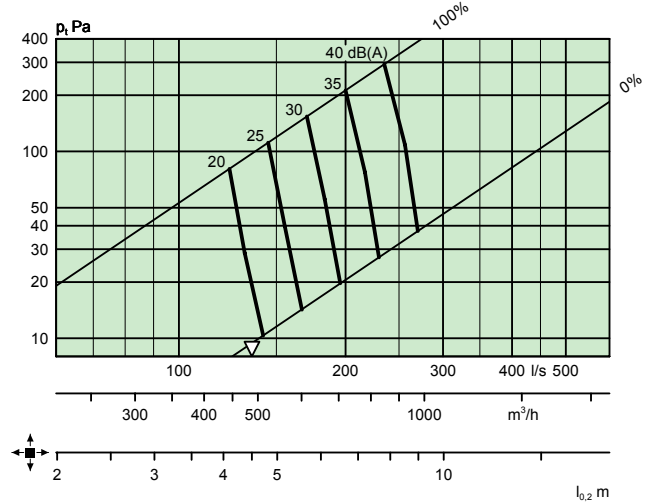

Shielding off the spread pattern

The air stream can easily be shielded off if there are obstacles, walls or other objects too close to the terminal. In order to be able to use the graphs for "Airflow - Throw length" and "Airflow - Pressure drop - Sound level" when the diffuser is shielding off in one sector, the airflow is corrected as in the adjoining diagram.

Example:

Desired airflow: 100 l/s

Sector shielding: 90°

Follow the line on the graph for 90° shielding and read off the correction factor of 1.2 on the vertical axis. Multiply the correction factor of 1.2 by the desired airflow of 100 l/s, giving 120 l/s. Use this airflow (120 l/s) when selecting throw length, pressure drop and sound level.

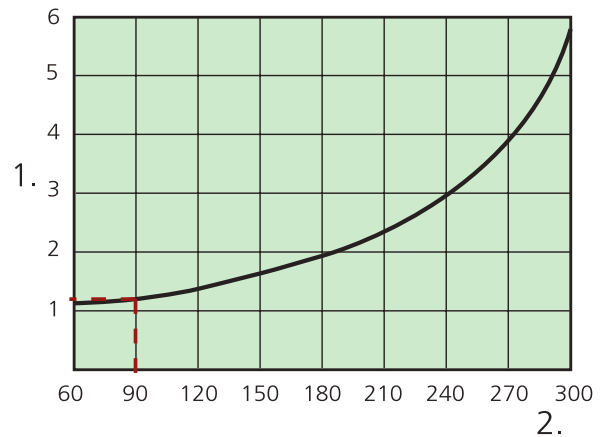

Figure 2. Correction factor for shielding.

1. Correction factor
2. Shielded (°)

Dimensions and weights

CDK/CKP

Size	ØA	Ød	E	ØJ	L	Weight, kg
100	192	99	36/46	125	51	0,6
125	228	124	36/46	160	56	0,8
160	304	159	46/56	215	73	1,3
200	380	199	46/56	280	87	1,8
250	456	249	50/60	350	95	2,5
315	568	314	50/60	450	114	3,7

ØJ = Hole-making size

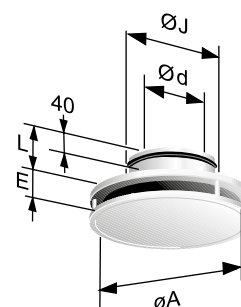

Figure 3. CDK/CKP.

CDK/CKP + ALS

Size	ØA	B	C	ØD	E
100	192	227	192	79	36/46
125	228	282	217	99	36/46
160	304	342	252	124	46/56
200	380	404	288	159	46/56
250	456	504	332	199	50/60
315	568	622	388	249	50/60

Size	F	G	H	K	Weight, kg
100	177	107	200	50	1,8
125	202	122	270	80	2,7
160	243	151	315	80	3,5
200	292	183	375	100	4,5
250	340	211	465	115	6,3
315	420	255	575	140	9,3

CL = Center line

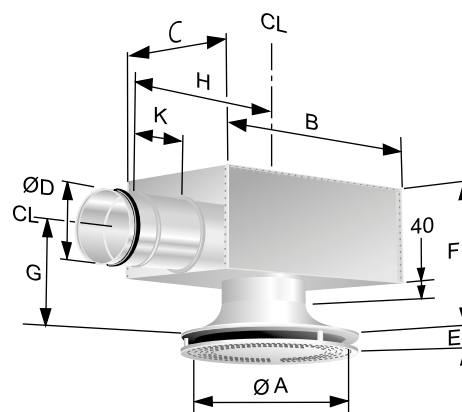

Figure 4. CDK/CKP + ALS.

Frame SAR C

Size	M	Ø L
100	40	187
125	40	223
160	65	299
200	65	375
250	100	451
315	100	563

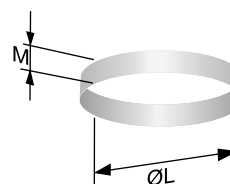

Figure 5. SAR C.

Ordering key

Product

Circular ceiling terminal with non-perforated front plate for supply air CDK a -bbb

Version:

Nom. connection dimension, mm

Circular ceiling terminal with perforated front plate for supply air CKP a -bbb

Version:

Nom. connection dimension, mm

Standard range:

Size: 100
 125
 160
 200
 250
 315

Accessories

Commissioning box ALS d -aaa-bbb

Version

For CDK/CKP ALS

100:	80-100
125	100-125
160	125-160
200	160-200
250	200-250
315	250-315

Frame SAR a C -aaa-bbb

Version:

C = circular

Size:

100	187-40
125	223-40
160	299-65
200	375-65
250	451-100
315	563-100

Sector shielding SAV a -aaa -bbb

Version:

Size: 100, 125, 160, 200, 250, 315

Shielded sector: 90°, 180°

Specification example

Swegons circular ceiling diffuser of the type CDK with commissioning box ALS, having the following functions:

- Spread pattern can be shielded
- Aerodynamically shaped inlet cone
- Cleanable
- Powder-coated in white, RAL 9003/NCS S 0500-N
- Cleanable commissioning box ALS with removable commissioning damper, lockable setting, measurement function with low method error and internal acoustic insulation with reinforced surface layer.

Accessories:

Frame: SARa C aaa - bbb xx items

Sector shielding: SAVa aaa - bbb xx items

Size: CDKa + ALSd aaa-bbb xx items