

actionair

TransShield ACS



**Fully Automated Intumescent Fire and
Sliding Plate Smoke Damper**

Introduction

The TransShield ACS fully automated intumescent fire and sliding plate smoke dampers are designed for air transfer applications through fire rated doors and walls. (Internal doors only).

The range of combined intumescent fire and smoke dampers can be used in all applications where **cold smoke containment** is required. These dampers are connected, via a control panel, to a standard fire alarm system. In event of an alarm condition, or power failure, the dampers shut, preventing the passage of cold smoke. These products have been designed to allow the smoke damper element to be used without the intumescent, in applications where only smoke and/or gas containment is required.

Air transfer products have many applications in new building and refurbishment projects. Ventilation through doors and walls is often a very cost effective means of improving air quality by better air distribution. However, the use of straight forward air transfer grilles often conflicts with the needs of fire safety, particularly where ventilation is required between fire compartments or into corridors and other 'means of escape' routes.

The TransShield ACS-D door mounted damper/air transfer products have been tested in door assemblies under the conditions of BS 476 Pt 22 to determine fire performance, and BS 476 Pt 31.1 to established smoke leakage criteria.

It is worth noting that a fire door illegally jammed open to allow air movement, or a fire door which cannot be opened or closed properly due to differential air pressure, is potentially a major hazard.

Ventilation engineers have found the flexibility of the design that the automatic fire and smoke dampers provide, contribute to versatile installations which meet the demands of good air quality and fire safety requirements.

Computer rooms and communications centres are often protected from the spread of fire by the use of halon substitute gases. The nature of these environments demand good air movement but, in the event of a fire, the

containment of the fire suppressant gases is imperative. Once the fire is out, it is also important to be able to automatically ventilate the enclosure to allow the earliest human occupancy. The TransShield ACS fire and smoke damper/air transfer grilles will satisfy these needs entirely.

The Range

Fire resistant air transfer grilles for a range of applications and fire performance levels are available in the form of intumescent damper/air transfer grilles. These products react to temperatures in excess of 100 °C, whereupon the swelling of the intumescent material seals the entire aperture area. This system, whilst very effectively preventing the spread of fire through air transfer apertures in fire doors, walls or ducts, does not control the movement of cold smoke or fire extinguishing gases.

To satisfy this requirement the TransShield ACS will, when combined with intumescent damper/air transfer grilles, provide complete fire and smoke protection.

The smoke control systems are intended to be interfaced with a fire alarm panel via the Talkpac panel.

It is possible to connect the Talkpac panel direct to 'stand alone' smoke sensors without an interface with the building alarm panel. This should only be undertaken after consultation with the Fire Authorities and the Actionair Sales Office.

The TransShield ACS smoke control system satisfies the need offering up to sixteen dampers per control panel with full status monitoring and automatic cycling facilities.

Special control systems can be supplied to suit specific customer installation needs.

All relevant components in the smoke control systems have been tested to the appropriate standards in conformance with Electro Magnetic Compatibility and Low Voltage Directives.

Talkpac Control System

Most large public buildings, high rise offices, hospitals and hotels require a significant number of FD30S and FD60S fire doors (30 minute or 60 minute fire doors with smoke leakage constraints), within any one fire zone. These doors may spread over a considerable distance and may even be at different floor levels, and may have to provide air transfer. Additional air transfer may be required through wall apertures or duct openings.

The Talkpac system has been designed to provide up to 16 damper/air grille locations with one centralised status monitoring location. The unique 2-way communication system between the Talkpac panel and the damper actuators facilitates rapid assessment of the installation and immediately identifies the location of a defective damper.

For external application please refer to Actionair Sales Office.

Features

Fail-Safe

Designed to close automatically in the event of a fire alarm being activated, a power failure or wiring damage.

Auto Reset

Will reset automatically to the open position when the fire alarm is cancelled or power restored.

Autocycling

Once in every twenty four hours each damper is closed and re-opened to prevent a build up of dust or debris between moving parts.

Loop Wiring

Up to 16 dampers can be connected via a 3-core cable which can be arranged in a ring. The wires from the Talkpac panel to the dampers carry only safe low DC voltages. (Refer to page 9 for wiring details).

Continuous Monitoring

TransShield ACS dampers/air transfer grilles are monitored continuously by the Talkpac panel which identifies the status of each individual damper through its uniquely – addressed chip.

Positive Closing

Energy stored within a capacitor on each damper actuator is used to power the electric motor to the closed position in the event of a fire alarm being activated.

Solid State

Solid state microchip technology is employed to provide versatility and reliability.

Assembled Tested

Each damper is assembled and fully tested, therefore requiring no adjustment on site, facilitating simple installation.

Standard sizes available (mm)

200mm wide x 200mm square unit
300mm wide x 300mm square unit
450mm wide x 450mm square unit.

Effective Free Area

0.012 m² 200mm x 200mm
0.027 m² 300mm x 300mm
0.061 m² 450mm x 450mm.

Compatibility

The Talkpac system is designed to interface with any fire alarm panel and subsequent to initial installation, additional dampers can be incorporated where there are free channels in the system.

C E Marking

Successfully tested in accordance with the requirements of Electro Magnetic Compatibility and Low Voltage Directive, and therefore bears the CE mark.

1 hour fire rating Door mounted

2 hour fire rating Wall mounted.

TransShield ACS-D

Door Mounted



TransShield ACS-W

Wall Mounted



TransShield ACS-D

Door Mounted

Non-Vision Fire and Smoke Containment Damper

TransShield ACS-D is a non-vision style fire and smoke damper designed to fit into a door (minimum 44mm thickness). They come complete as a factory tested product with decorative flanges to suit. These products require no cover grilles as the slat components are angled to ensure visual privacy and are finished in white. Operation of the smoke damper would be through the Talkpac control panel. Up to 60 minutes fire resistance can be achieved with this product.

Orientation

These products are designed to be installed in a vertical orientation as shown.

Standard Sizes Available (mm)

- 200mm wide x 200mm high
- 300mm wide x 300mm high
- 450mm wide x 450mm high.

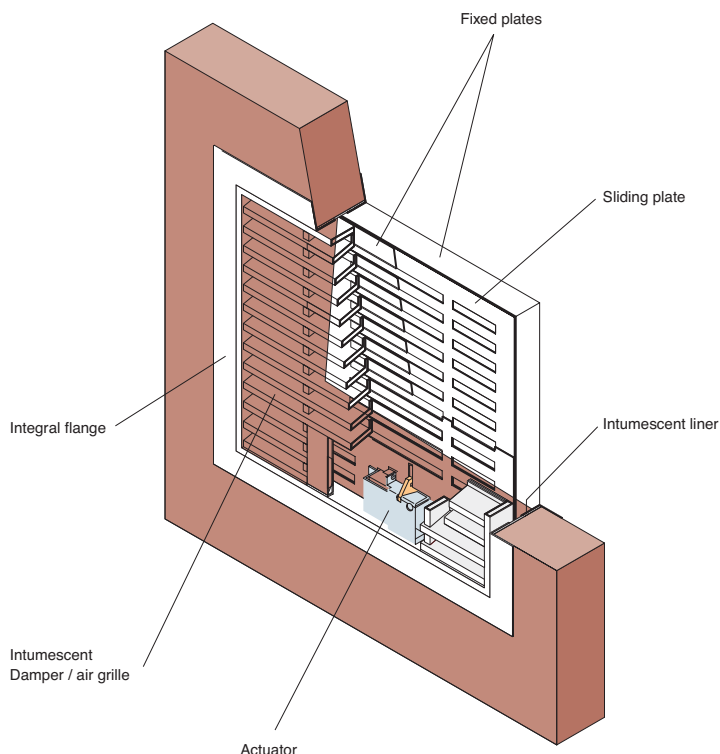

Damper Fitting Instructions (ACS-D)

Ensure that cutting an aperture in the door will not detract from the fire integrity of the door. Contact the manufacturer to establish the maximum size and optimum position.

The initial installation of this type of damper is best carried out with the door dismounted. If rebated threshold seal is to be fitted this should be done temporarily before fitting the damper assembly and then removed.

TransShield ACS dampers are supplied 2mm less than the nominal size

e.g. a 300mm x 300mm is actually 298mm x 298mm.

The flange requires a minimum of 6mm extra clearance overall.

e.g. overall dimension of a nominal 300mm x 300mm damper will be 304mm x 304mm.

Overall flange dimension 348mm x 348mm.

1. Cut the aperture to the required size with a maximum gap all around the outside of the flange of 3mm.

2. Check that the two halves of the damper fit into the aperture without twisting, jamming, or in any way distorting.

3. Remove them from aperture.

4. Drill vertical outer frames of each damper and flange sub assembly to accept fixing screws.

5. Drill and rebate door to provide wiring route to conductor hinges or loop connection. (Supply and fit by others).

6. Fit intumescent inserts to the inside faces of the aperture.

7. Fit the damper sub assembly that incorporates the actuator into the aperture, ensuring that the actuator is at the bottom of the aperture. Route the wiring into the required connection (hinge or loop) ensuring that it lies tidily and does not cause any distortion of the damper, or is likely to become trapped.

8. Fit retaining wood screws through pre-drilled holes in damper vertical outer uprights into door.

9. Refer to wiring instructions.

10. Carry out a function check of the damper by activation from the Talkpac panel whilst actuator is visible and wiring accessible, before fitting the remaining half of the damper.

11. After satisfactorily completing function check, fit the remaining half of the damper assembly ensuring that the smoke control sliding plates do not become squeezed between the two damper halves or wiring becomes trapped.

12. Repeat the function check on complete installation.

TransShield ACS-D Assembly

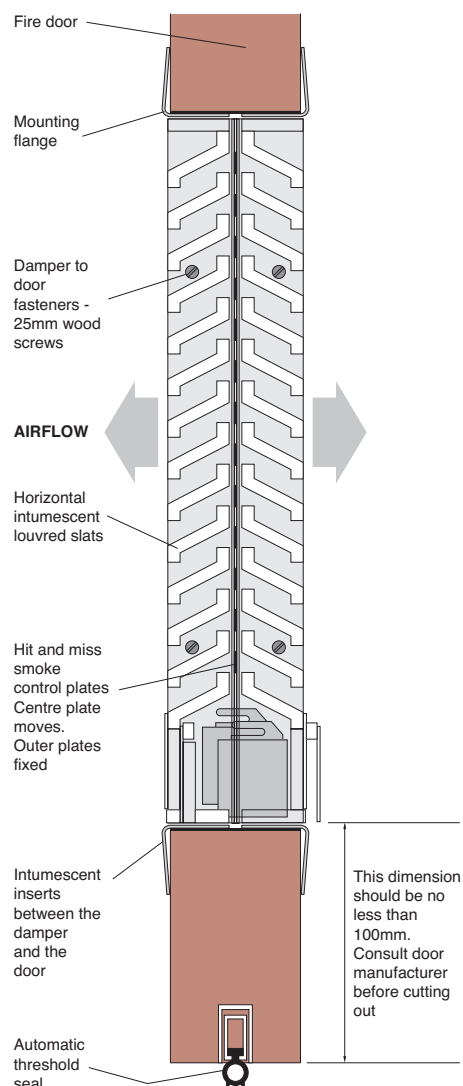

Performance Criteria

The acoustic and aerodynamic performance is based on a **door mounted** application with a TransShield **ACS-D** fire and smoke rated intumescent damper.

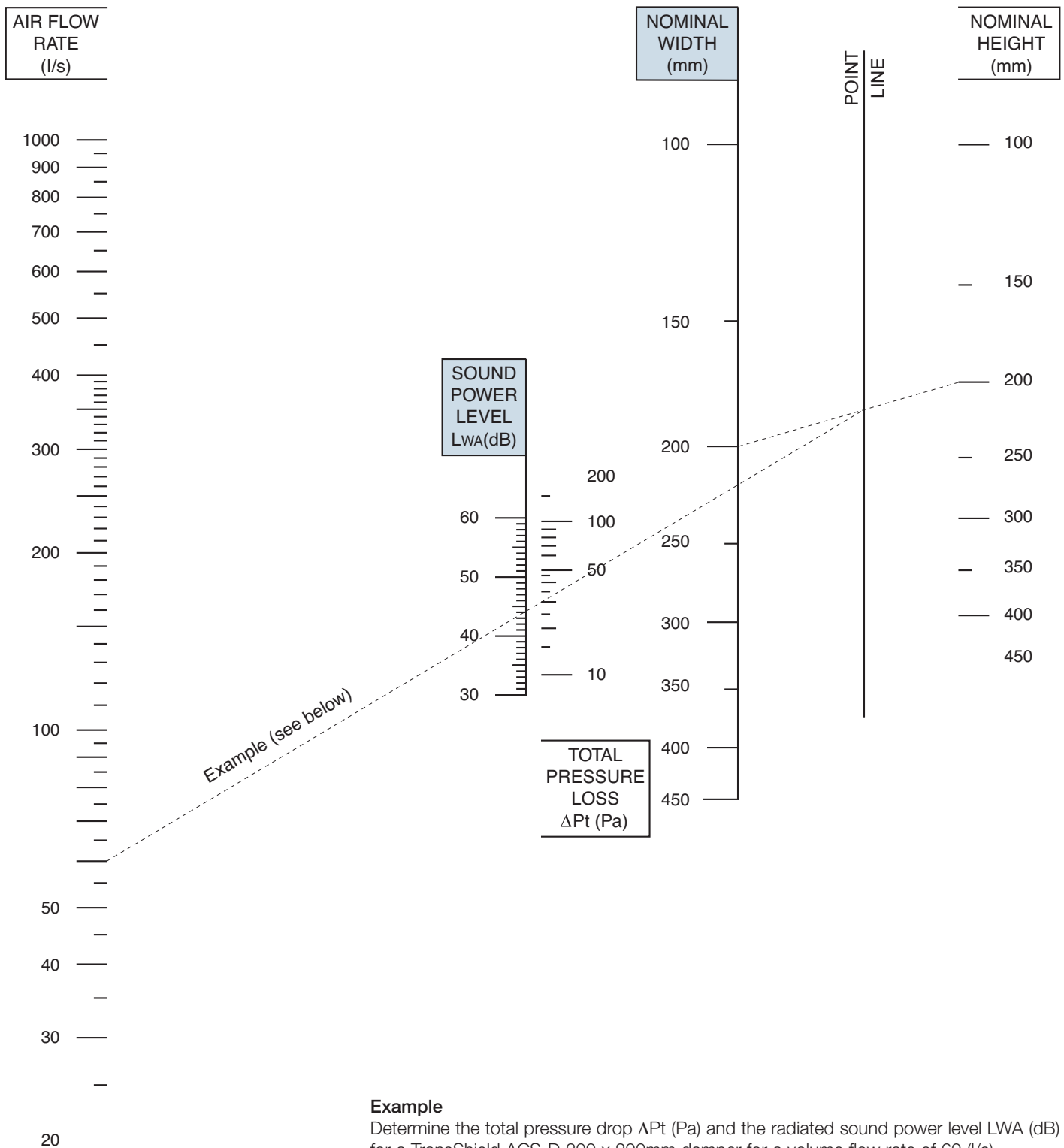

Example

Determine the total pressure drop ΔPt (Pa) and the radiated sound power level LWA (dB) for a TransShield ACS-D 200 x 200mm damper for a volume flow rate of 60 (l/s).

On the chart, draw a straight line from 200 on the nominal width axis to 200 on the nominal height axis. At the intersection point with the pivot line, draw a line to 60 (l/s) on the flow rate axis. The radiated sound power LWA (dB) and total pressure drop ΔPt (Pa) may now be read directly.

Type: TransShield ACS-D 200 x 200mm

Flow rate(l/s): 60

Total pressure drop (Pa): 42

Radiated sound power LWA (dB): 45

TransShield ACS-W

Wall Mounted

Non-Vision Fire and Smoke Containment Damper

Wall mounted fire and smoke dampers are supplied as factory tested units complete with steel cover grilles. The non combustible housing containing the shutter plate system and intumescent damper is manufactured to the depth of the wall (minimum 100mm) allowing simple and quick installations on site. Up to 120 minutes fire resistance can be achieved with this product. Operation is through a Talkpac control panel.

Key Features

- 120 minutes fire resistance
- Containment of cold smoke
- Supplied as a tested assembly
- Simple installation
- Auto reset and failsafe
- Safe low DC voltage
- Status reporting and autocycling
- Optional audible warning facility
- No current used when open or closed
- Bi-directional airflow.

General

The TransShield ACS damper is designed to be linked with smoke sensors via a fire alarm panel and therefore provide excellent hot and cold smoke containment. The combination of intumescent and electro-mechanical technologies allows proven fire resistance with very good insulation properties. Remarkably little current is used by the servo motor when opening or closing the smoke shutter module and none is drawn when the shutter plates are either closed or open. The units can be supplied to suit a range of wall thickness and aperture sizes. Pressed steel cover grilles are supplied in a white finish.

Specifications

Materials

The damper casing is manufactured from high grade mineral board and is supplied complete with the fire damper and smoke shutter fully assembled.

Orientation

These products are designed to be installed in a vertical orientation as shown above.

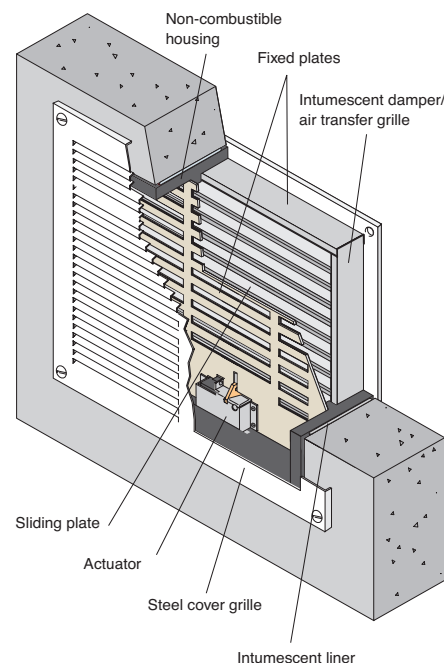

Standard sizes available (mm)

200mm wide x 200mm high
300mm wide x 300mm high
450mm wide x 450mm high.

Depths available 100,150,200,225,250 and 300mm.

Damper Fitting Instructions (ACS-W)

The damper is supplied ready assembled in a mineral board casing. Care must be taken not to damage the casing during installation.

1. Cut the aperture to the required size with a maximum gap all around of 5mm. (e.g. for 200mm sq, cut at 245mm). If the resulting aperture is out of square, irregular or over sized, make good with mortar.
2. Remove cover grilles.
3. Drill the casing for wall fixing screws, a minimum of 4 holes will be required.
4. Trial fit the damper assembly into the aperture and ensure that it can be positioned within the section of the wall, without jamming or twisting.
5. Position the damper assembly so that one face is flush with one face of the wall.
6. Mark around the damper casing at the opposite face to determine the amount needed to be removed to give a flush fit on both faces. Also mark the positions of the wall fixing screws through the holes drilled.
7. Establish the actuator cable run and make the necessary cut outs to suit.
8. Remove the damper assembly from the wall aperture.

9. Trim the damper casing to the marked length.

10. Drill the wall for screw plugs and fit plugs.

11. Apply intumescent mastic to aperture faces. Position damper assembly square and flush to both faces of the wall while feeding the actuator cable into the selected position.

12. Fit casing fixing screws to the wall.

13. Bed in mastic around damper casing. Clean off surplus mastic and ensure outer edge of damper casing is fully sealed.

14. Fix actuator cable to casing with small cable clips to prevent it fouling the shutter plates.

15. See wiring instructions.

16. Carry out function check of the damper by activation from the Talkpac panel. After satisfactorily completing the function test, position a pressed steel cover grille concentrically over one face of the damper and fix using screws into wall plugs. Repeat with other grille.

Overall grille dimensions are nominal size plus 100mm.

TransShield ACS-W Assembly

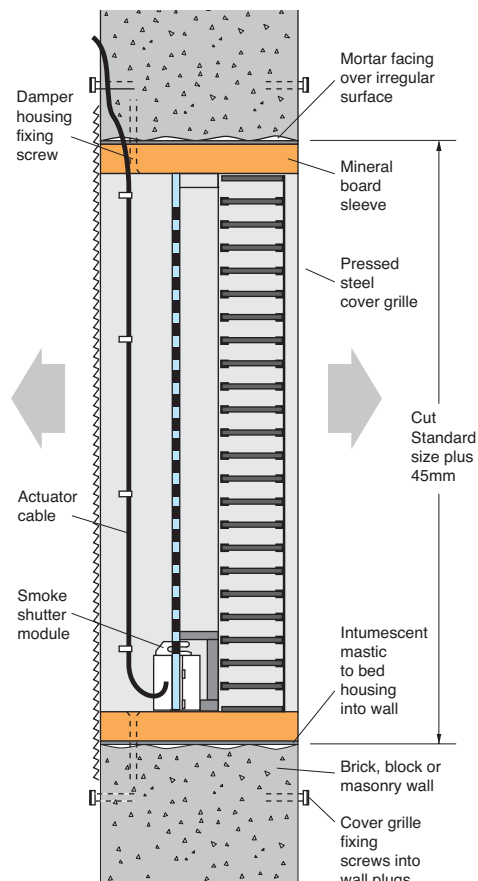

Performance Criteria

The acoustic and aerodynamic performance is based on a **wall mounted** application with a TransShield **ACS-W** fire and smoke rated intumescent damper fitted with cover grilles.

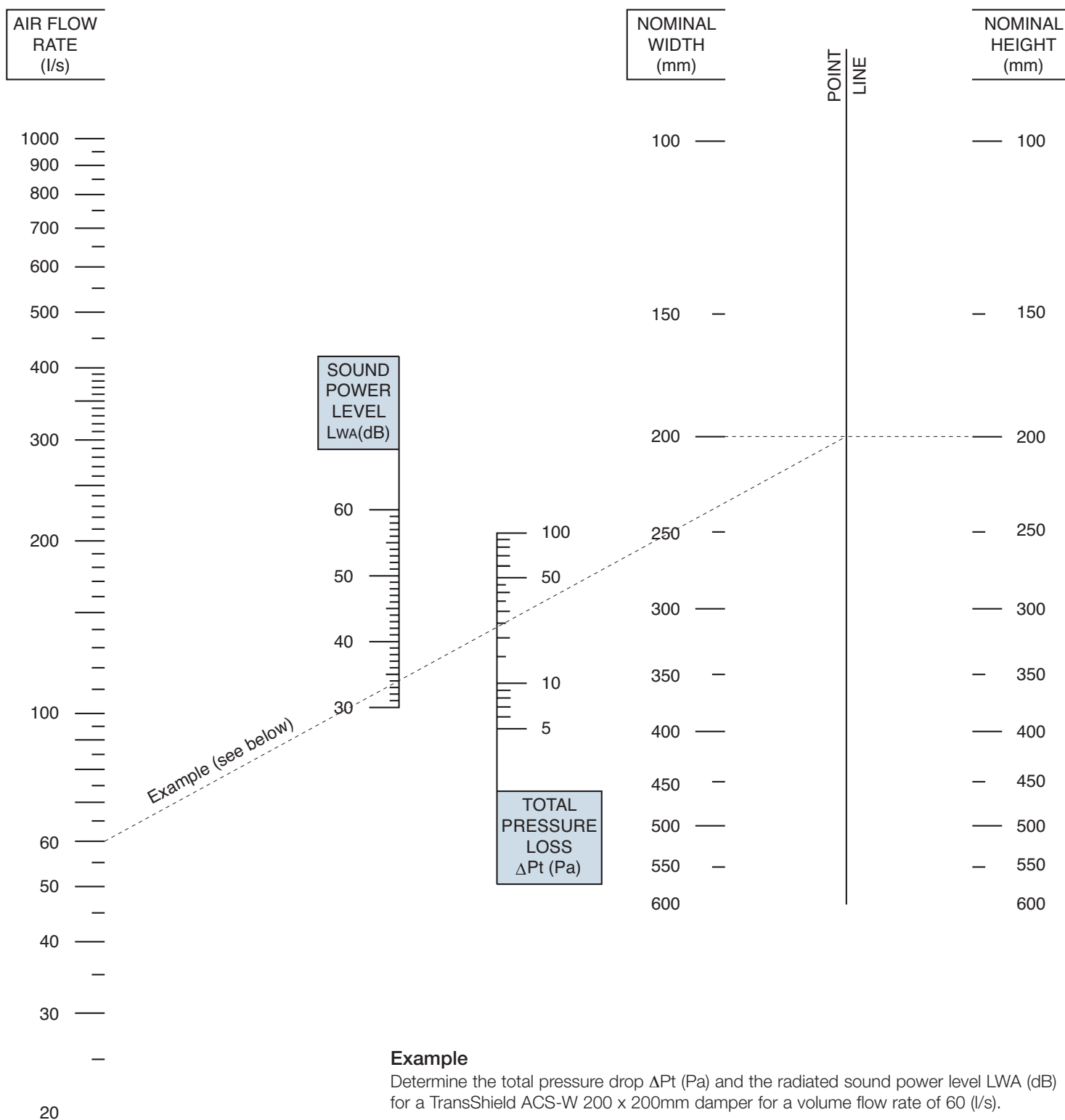

Example

Determine the total pressure drop ΔPt (Pa) and the radiated sound power level LWA (dB) for a TransShield ACS-W 200 x 200mm damper for a volume flow rate of 60 (l/s).

On the chart, draw a straight line from 200 on the nominal width axis to 200 on the nominal height axis. At the intersection point with the pivot line, draw a line to 60 (l/s) on the flow rate axis. The radiated sound power LWA (dB) and total pressure drop ΔPt (Pa) may now be read directly.

Type: TransShield ACS-W 200 x 200mm

Flow rate(l/s): 60

Total pressure drop (Pa): 23

Radiated sound power LWA (dB): 34

Talkpac Damper Control System

Application

The Talkpac system provides monitoring and control for up to 16 uniquely addressed TransShield ACS Units form a centralised status monitoring location.

The unique 2 way communication system ensures rapid installation assessment and immediate identification of the location of a defective damper.

The interconnecting 3-core cabling, installed as a loop, provides for greater reliability and maximum range. It may be spurred if necessary.

An audible warning device drawing attention to the panel's status display, should a fault occur, can be connected to the panel as an optional extra.

Within the panel is a connection for battery back up. An appropriate battery and enclosure is available at extra cost.

Talkpac panel

This unit provides DC power, and monitors the status of dampers whilst interfacing with the fire alarm.

The display panel contains three rows of LEDs.

- The top row of green LED's indicates the dampers are open as per command.

- The bottom row of greens LED's indicates during a test cycle that the dampers are closed as commanded.

- The middle row of red LED's indicates a fault or an unconnected channel.

Therefore, each vertical group of three LED's (i.e. Green, red and green) gives the status of the corresponding damper, i.e. open, fault, closed.

There are two methods of interfacing the panel with a fire alarm panel:-

A. A signal generated by the Talkpac panel from the terminals marked  (see page 11) can be passed through a normally closed volt free contact on the alarm panel.

Or

B. If the alarm panel has a spare 24 volt DC signal output, which is normally live but ceases in the event of an alarm, this output can be wired to the FA (Aux) terminals in the panel (see page 11).

Sequence of operation during initial powering up.

1. The panel converts 230V AC to 12.8V DC At this stage, an alarm condition is indicated until the system is stabilised.

2. Each ACS damper is then instructed over the next few seconds, to open according to its particular address. Once opened, each damper confirms back to the panel within 20 seconds of receiving instructions. All top row green LED's should then remain lit.

3. Every 10 seconds, the panel then sends a signal to each damper actuator which in turn signals back to the panel that it is conforming with instructions; or a fault is assumed.

4. If a damper fails to open fully, no confirmation signal is received by the panel for that particular damper and the red LED will illuminate.

5. Subsequently, the panel provides a continuous status update.

6. In a test or real alarm situation, each damper will be instructed to close and all bottom row green LED's should then be lit.

7. If a damper fails to receive the panel signal within 10 seconds, a fault or alarm is assumed, the damper will fail safe closed.

8. For test purposes a rotary switch is incorporated in the panel, which should be operated by a non metallic screwdriver.

9. Simulated alarm conditions are automatically conducted every 24 hours during the auto-cycle.

Wiring Information

As each damper within a system has an individual code, a 3-core cable is needed to provide a means of supply and signalling to each unique address.

Maximum cable lengths

1. With 1mm² wire provides a ring system of a maximum circumference of 100 metres. If installed radially or spurred the maximum length is 50 metres.

2. With 2mm² wire provides a ring system of a maximum circumference of 200 metres. If installed radially or spurred the maximum length is 100 metres.

3. With 2.5mm² wire provides a ring system of a maximum circumference of 250 metres. If installed radially or spurred the maximum length is 125 metres. These cable runs can be extended by increasing the wire cross sectional area.

Conductor hinge

Where door mounted dampers are required, power and signal from the panel can be introduced to the door leaf by means of a specifically designed multi-wired conductor hinge. Therefore, the wiring can be completely concealed and is less vulnerable to tampering.

The enclosure measures 175mm (w) x 160mm (h) x 130mm (d) overall.

Access for wiring connections is through a screw fixed panel in the lower section of the enclosure.

Optional Audible Alarm BMS Interface

The optional Audible Alarm BMS Interface monitors the number of dampers connected to the system. Should one of the dampers fail, the unit will give an audible alarm as well as changing the BMS contacts from closed to open.

Please refer to the wiring diagrams and the fitting instructions before attempting installation.

Talkpac Damper Control System Schematic Wiring Installations

Diagram A
Ringed Wiring Installation.

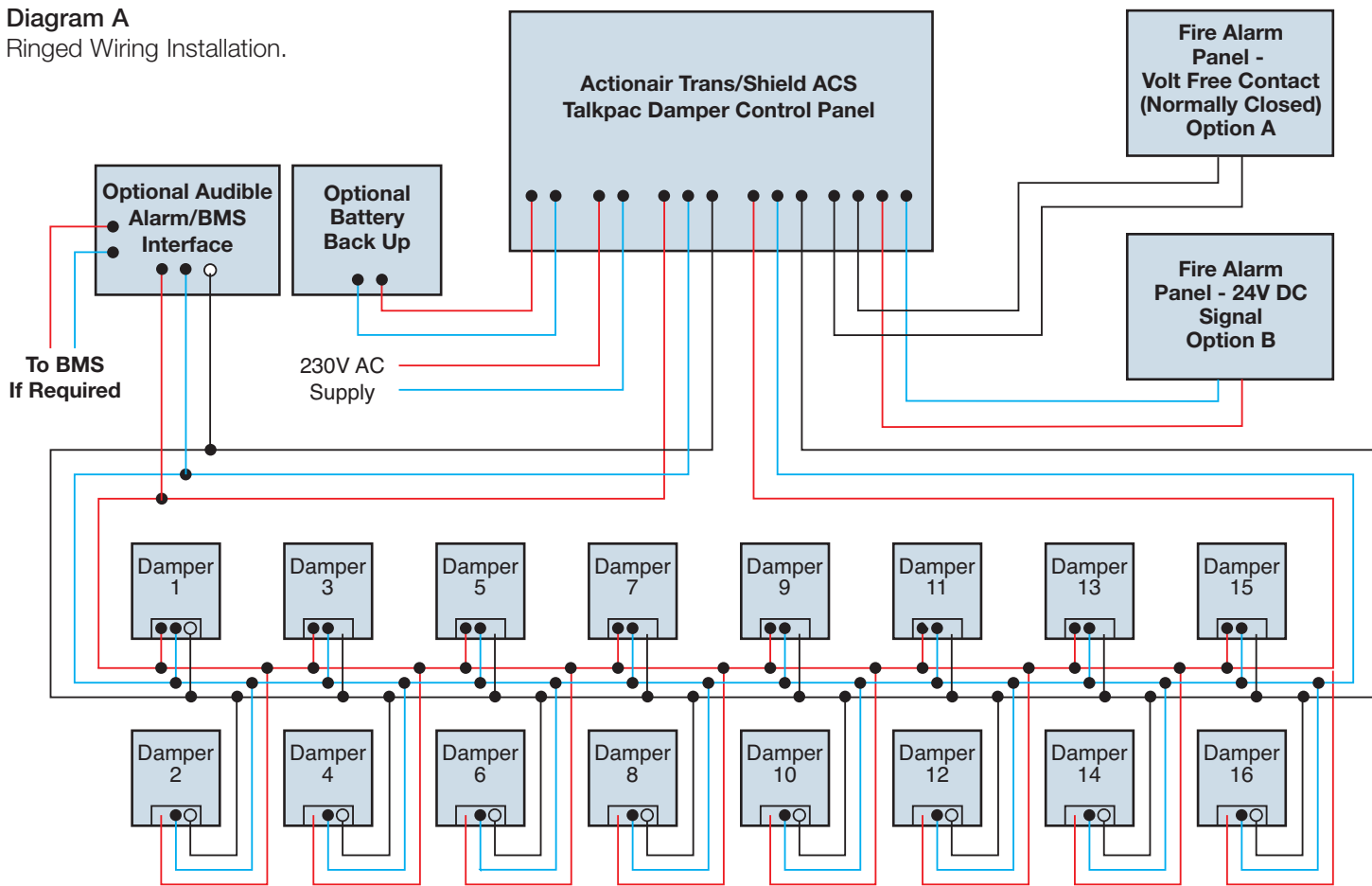
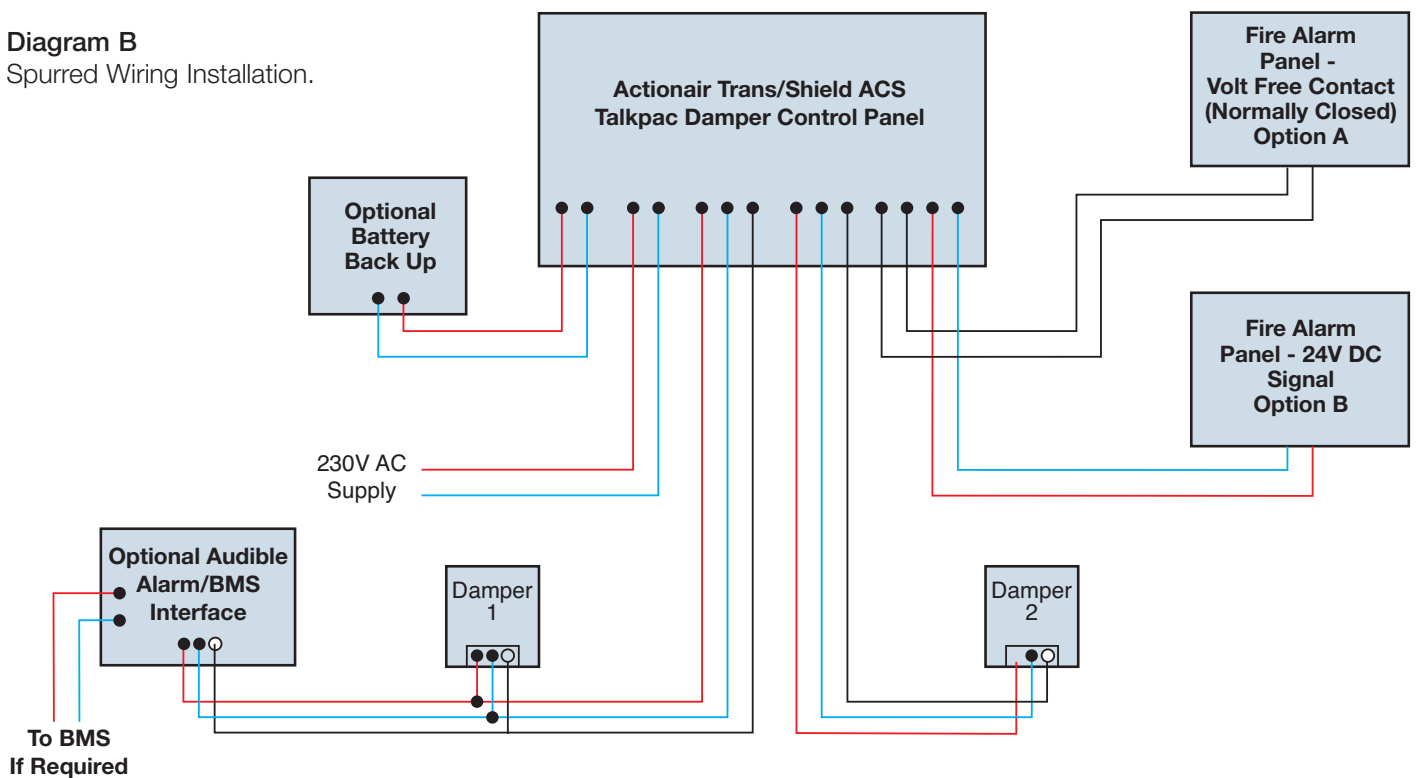

Diagram B
Spurred Wiring Installation.



Talkpac Damper Control System Schematic Wiring Installations

Diagram C

Connections within Talkpac Damper Control Panel

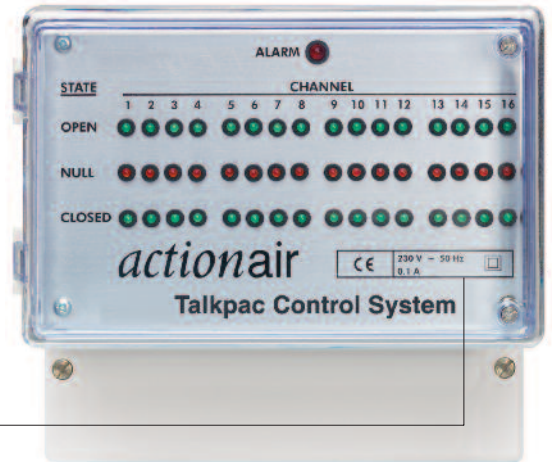
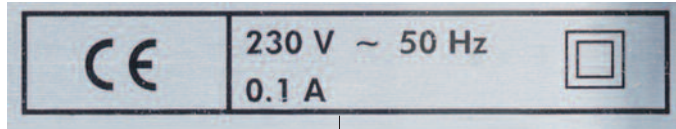

Optional
Battery
Back Up

Mains
Supply
230V AC

Supply and
Signal to
Dampers
12.8V DC

Supply and
Signal to
Dampers
12.8V DC

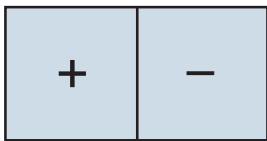

The function of the actuator is to open the damper in accordance with the alarm status as interpreted by the panel. (The actuator uses a geared electric motor which provides a powerful action but with minimal current consumption, typically 5 milliamps when the damper is in the open position and 200 milliamps momentarily when in the process of opening.)

On power failure, energy stored within the actuator PCB capacitor is tapped to drive the motor to the closed position. In the event of an alarm the panel instructs the actuator to close using the power supply from the panel. A Phototransistor confirms the final position of the damper and sends a signal to the panel, which illuminates a green LED on the bottom row. This indicates that the damper is closed. If no signal is received from the actuator by the panel within 10 seconds, a fault is assumed and a middle row red LED is illuminated.

Alarm cancellation or power restoration will trigger the panel to signal the actuator to move the damper to the open position, the final position of the damper being sensed by another photo transistor and

reported to the panel for display.

Should the actuator not receive a signal from the panel within a 10 second period, it will assume failure and close the damper.

CE Marking

EMC and LVD (Electro Magnetic Compatibility and Low Voltage Directive).

Actionair smoke control systems have been successfully tested in accordance with the requirements of EMC & LVD and, therefore, bears the CE Mark (Conformite European).

Copies of the relevant test reports are available on request.

Actionair electro-mechanical systems should only be installed by qualified and competent technicians, working strictly to the relevant Actionair fitting instructions. Any proposed deviation from the original design or installation instructions must be sanctioned by Actionair's technical staff.

System users are advised that servicing or retrospective installation modifications must be undertaken by the installers, or a technically competent contractor who is totally familiar with the relevant system and is in possession of the appropriate Actionair technical data sheets.

Alarm Interface Options A or B

Connect to
a volt free
(Normally closed)
contact on
Alarm Panel
(Opens on Alarm)



A

Connect to
24V DC signal
from Alarm Panel
(Normally on,
off in Alarm)

AUX

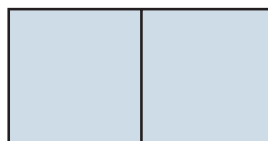

B

Rotary test
switch



Specification (ACS-D)

1. The TransShield ACS-D shall comprise of an assembly with three slotted plates, two fixed and one sliding plate allowing air transfer when in the open position. This is fail-safe operated, closed by motorised actuator to prevent the passage of cold smoke in the event of an alarm or power failure.

2. The non-vision grilles each side of the sliding plate assembly are manufactured from P.V.C. slats with an intumescent core. An increase in temperature resulting from either flames or hot gases causes the grille to intumesce, fusing together to provide an effective barrier to the passage of fire and hot smoke. This complies to BS476 Part 20: 1987 for a period of 1 hour and the leakage requirements of BS476 Part 31: Section 31.1.

3. TransShield ACS-D are available in 3 sizes, 200mm x 200mm, 300mm x 300mm and 450mm x 450mm having respective effective free area of 0.012m², 0.027m² and 0.061m².

Specification (ACS-W)

1. The TransShield ACS-W shall comprise of an assembly with three slotted plates, two fixed and one sliding plate allowing air transfer when in the open position. This is fail-safe operated, closed by motorised actuator to prevent the passage of cold smoke in the event of an alarm or power failure.

2. The wall mounted unit incorporates a non combustible housing and intumescent damper: white painted press steel grilles are provided on each side. An increase in temperature resulting from either flames or hot gases causes the damper to intumesce, fusing together to provide an effective barrier to the passage of fire and hot smoke. This complies to BS476 Part 20: 1987 for a period of 2 hours and the leakage requirements of BS476 Part 31: Section 31.1.

3. TransShield ACS-W are available in 3 sizes, 200mm x 200mm, 300mm x 300mm and 450mm x 450mm having respective effective free area of 0.012m², 0.027m² and 0.061m².

Talkpac Damper Control Panel Dimensions (Millimetres)

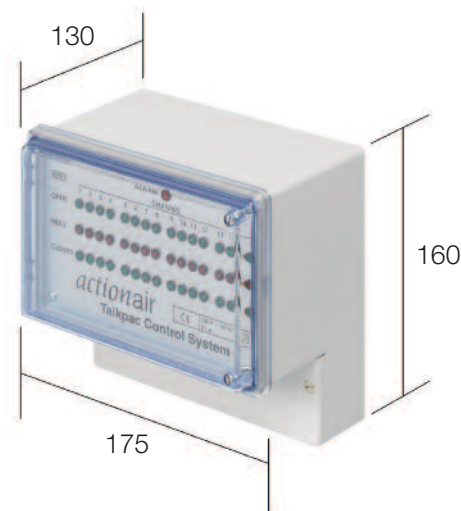

Regulatory Requirements

Approved Document B to the Building Regulations (England and Wales) Part E of the Scottish Technical Standards and Part E to the Building Regulations (Northern Ireland) give the requirements for fire and smoke containment with respect to 'means of escape'.

A study of these requirements shows that practically all internal fire door assemblies are required to prevent the passage of cold smoke. This needs to be considered separately from performance in relation to fire and hot smoke. Air transfer grilles must not compromise the smoke integrity of a doorset.

Relevant Standards

- BS 476 Pt.22: 1987 Methods of determination of the fire resistance of non-loadbearing elements of construction
- BS 476: Section 31.1 Methods for measuring smoke penetration through a doorset and shutter assemblies
- BS5588: Fire precautions in the design and construction of buildings. (An Approved Document for compliance with Building Regulations).

actionair | air diffusion | airfiltrera | airovolution | naco

South Street,
Whitstable,
Kent, CT5 3DU

Tel: +44 (0)1227 276100

Email: sales@actionair.co.uk

Website: actionair.co.uk

The statements made in this brochure or by our representatives in consequence of any enquires arising out of this document are given for information purposes only. They are not intended to have any legal effect and the company is not to be regarded as bound thereby. The company will only accept obligations, which are expressly negotiated for and agreed and incorporated into a written agreement made with its customers.

Due to policy of continuous product development the specification and details contained herein are subject to alteration without prior notice.