



**Anslut  
GLOBAL/ESENSA/SERENITY  
till Swegon INSIDE**

# Vilka enheter är INSIDE Ready?

## **GLOBAL/ESENSA/SERENITY**

med TAC7-styrenhet

- Måste ha tillbehöret "SAT INSIDE Ready"

## **Eftermonteringsfunktion**

- Alla TAC7-styrda AHU:er med tillbehöret "SAT WIFI-ETHERNET", minst v1.0.0



Så här ansluter du  
**GLOBAL/ESENSA/SERENITY-**  
enheter

# Ansluta GLOBAL, ESENSA eller SERENITY

## Ethernet-anslutning

Anslut den ena änden av nätverkskabeln till anläggningens befintliga nätverk och den andra till AHU (SAT INSIDE-kompatibel).

## Wi-Fi-anslutning

Anslut SAT INSIDE-enheten till Wi-Fi-nätverket. Det enklaste är att aktivera WPS på den lokala routern och trycka på WPS-knappen på SAT-enheten.

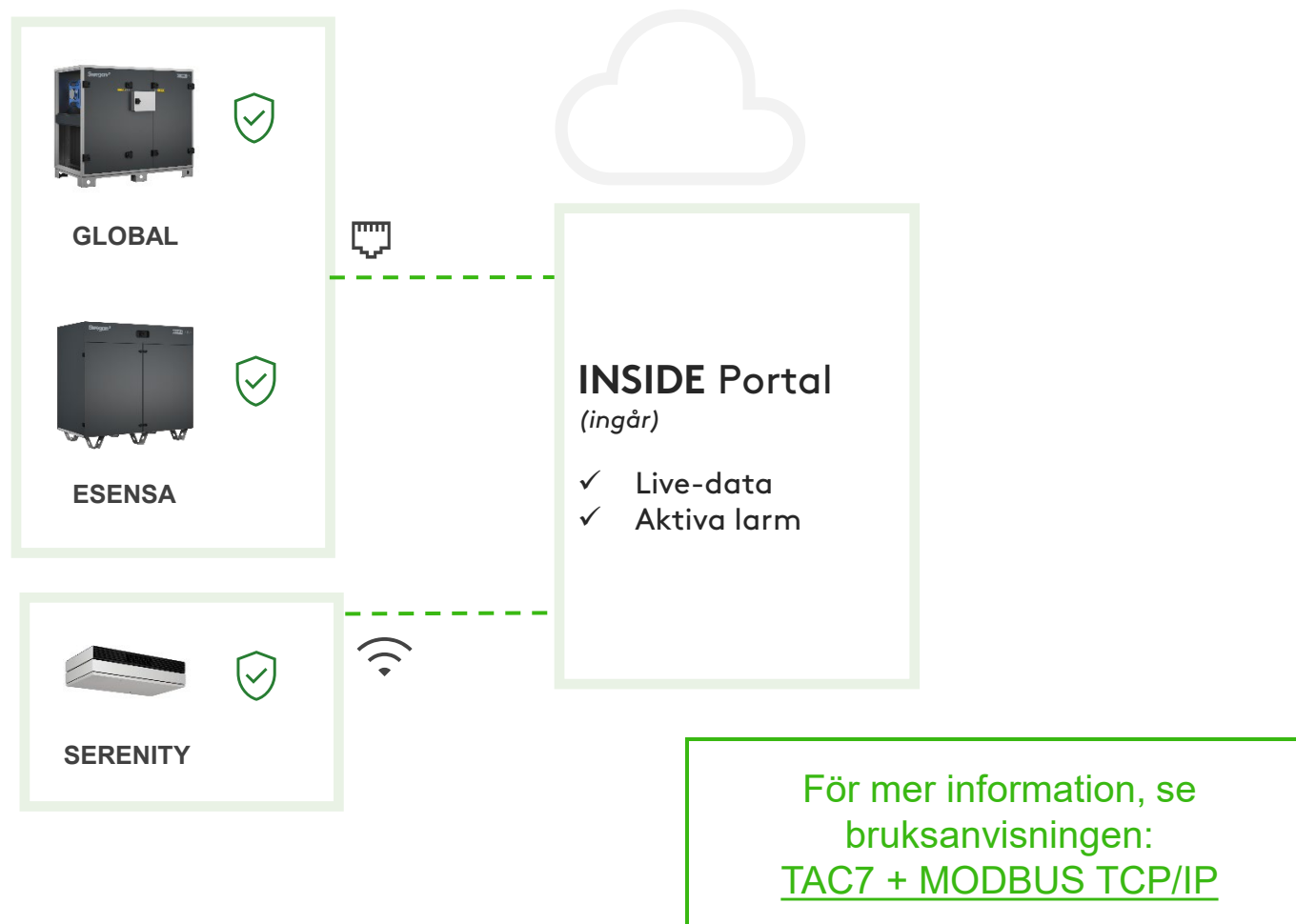

# Anslutningsinställningar i TACtouch

- Använda Wi-Fi: inga ytterligare inställningar krävs
- Använda Ethernet:
  - Leta upp "Kommunikation/Konfiguration av SAT LAN"
    - För IP-konfiguration, om det lokala nätverket har funktionen för dynamisk IP-konfiguration, vilket vanligtvis är fallet, välj DHCP
    - I annat fall väljer du Manuell och ser till att följande är korrekt ifyllt: IP-adress, nätmask, standardgateway, primär DNS
    - Tryck på "Validera" efter konfigurationen

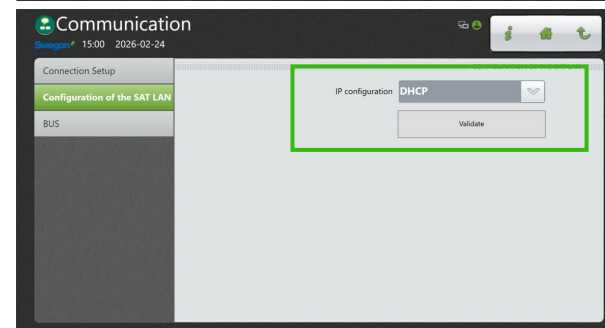
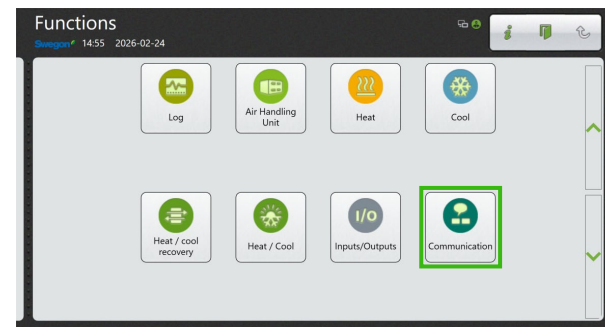
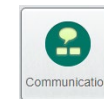

# INSIDE Connect – en Swegon-router

- Det går att använda Swegon-routern om det inte går att komma åt det lokala nätverket eller om det inte finns någon lokal internetanslutning. Följ dessa ytterligare steg:
- När du har placerat antennen och säkerställt att routern har en stabil 4G-signal ansluter du den till SAT med en vanlig Ethernet-kabel (RJ45). Observera att routern måste försörjas med +24 V DC enligt schemat.
- Konfigurera IP-inställningarna enligt tabellen. Gå till Funktion/Kommunikation/Konfiguration av SAT LAN

DHCP	Off
IP Address	169.254.235.1
Netmask	255.255.255.248
Default gateway	169.254.235.6
Primary DNS	8.8.8.8

# INSIDE Connect – en router från Swegon

## Kabelanslutning

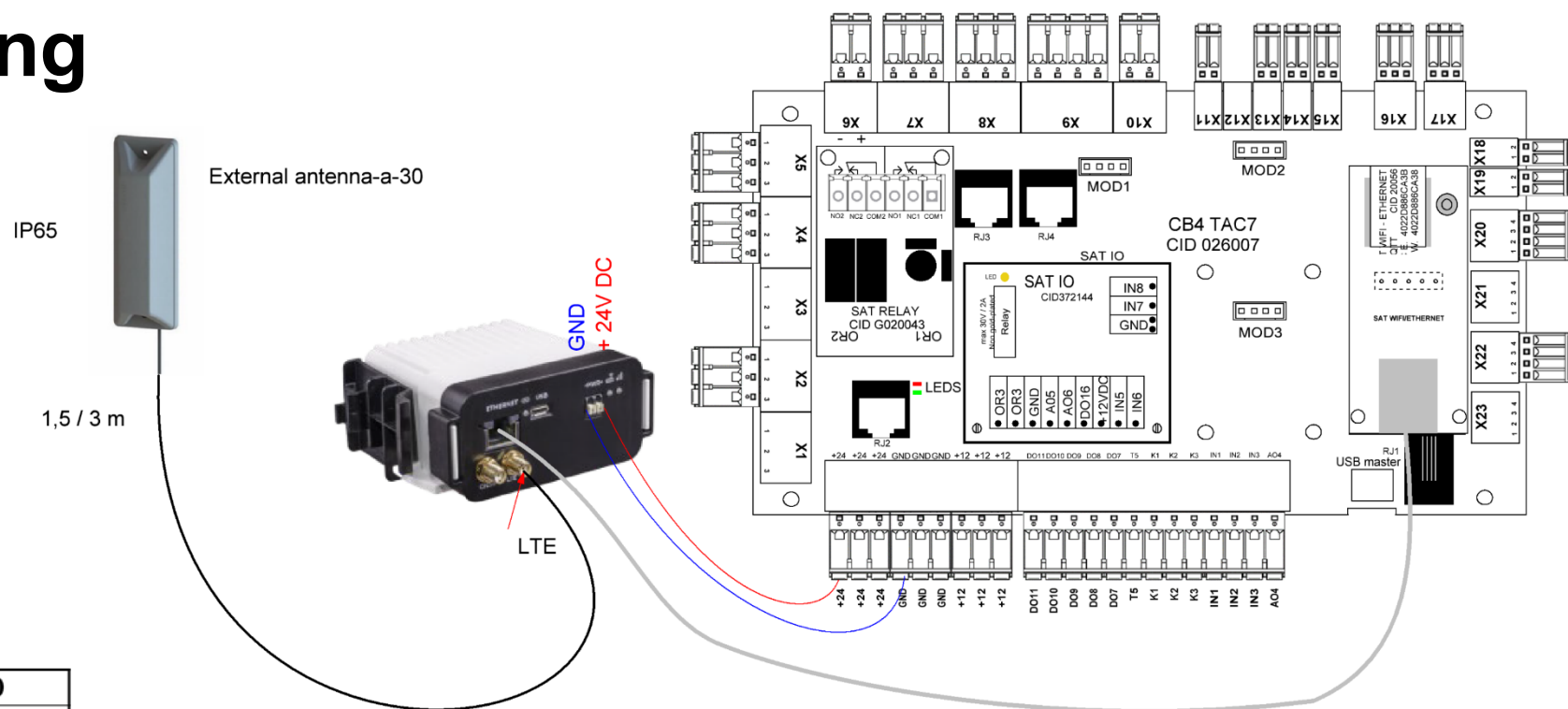



Label	CID
INSIDE Connect, fitted in electrical cabinet	883819
INSIDE Connect, delivered loose (no PSU)	883820
INSIDE External antenna-a-15	883821
INSIDE External antenna-a-30	883822

# Skapa konto

- Gå till [Swegons webbplats för digitala tjänster](#)
  1. Begär åtkomst till INSIDE Portal
  2. Fyll i formuläret och skicka
  3. Vänta på inbjudningsmejlet

**1.** Get started!

1. Request access to INSIDE Portal 

2. Claim product/make your product INSIDE Ready (Retrofit only) 

3. Go to INSIDE Portal 

**2.** Get started!

1. Request access to INSIDE Portal 

Enter details below to request a login.

If you already have an account and wish to add a new product or building, please contact [digitalservices@swegon.com](mailto:digitalservices@swegon.com)

**Account information**

Email (will be used as username)\*

First name\*

Last name\*

Company name\*

**Building and product information**

Choose product\*

Serial number of product\*

Building name\*

Building address\*

City\*

Country\*

Swegon needs the contact information you provide to contact you about the requested service. You may unsubscribe from these communications at anytime. For information on how to unsubscribe, as well as our privacy practices and commitment to protecting your privacy, check out our [Privacy Policy](#).

protected by reCAPTCHA   
Privacy - Terms

**SUBMIT**

# Logga in på INSIDE-portalen

<https://inside.swegon.com>

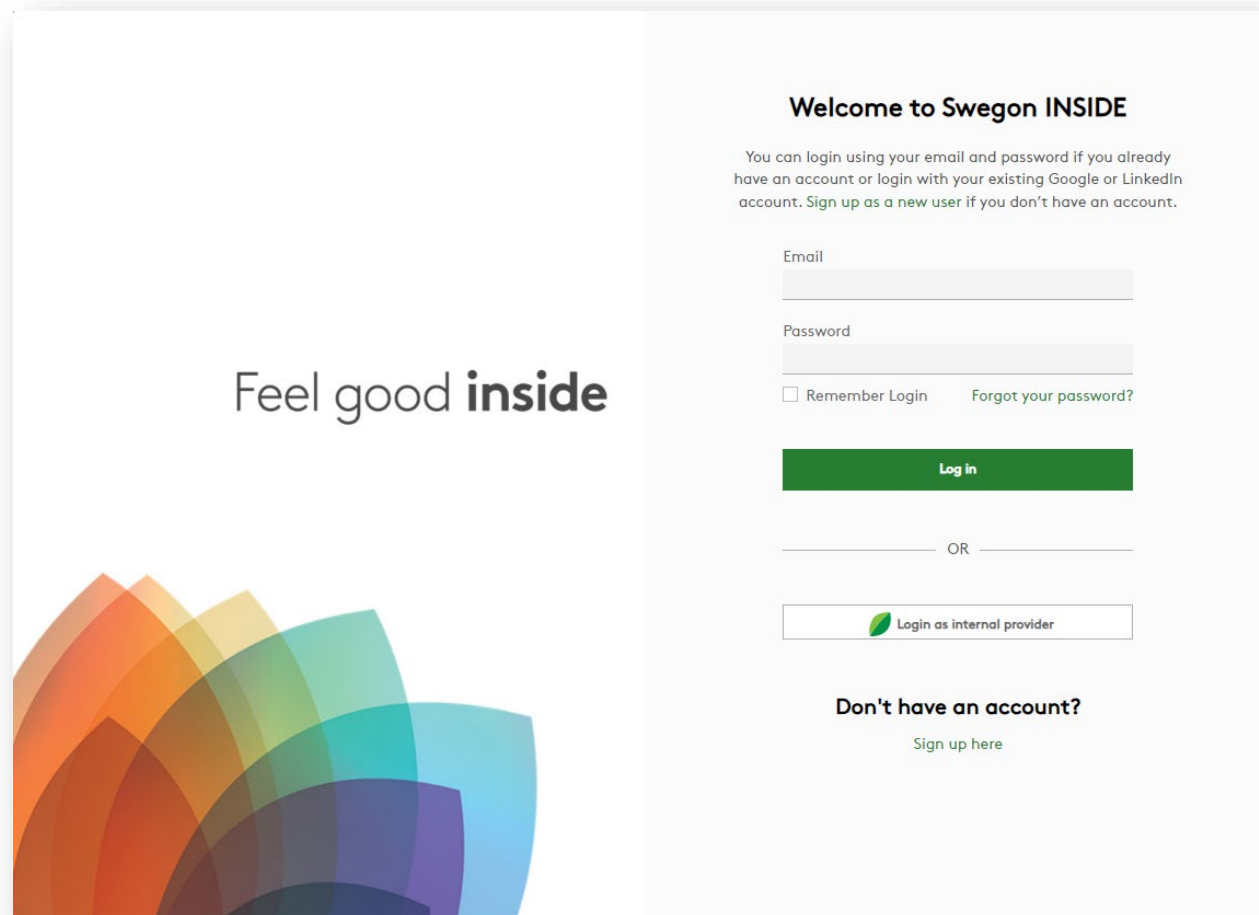

The screenshot shows the Swegon INSIDE login interface. On the left, there is a decorative graphic of overlapping semi-circles in various colors (orange, yellow, green, blue, purple) and the text "Feel good inside". On the right, the login form is titled "Welcome to Swegon INSIDE". It includes a welcome message, input fields for "Email" and "Password", a "Remember Login" checkbox, a "Forgot your password?" link, a green "Log in" button, an "OR" separator, a "Login as internal provider" button with a leaf icon, and a "Don't have an account?" section with a "Sign up here" link.

Feel good **inside**

**Welcome to Swegon INSIDE**

You can login using your email and password if you already have an account or login with your existing Google or LinkedIn account. Sign up as a new user if you don't have an account.

Email  
[Input field]

Password  
[Input field]

Remember Login    [Forgot your password?](#)

**Log in**

OR

 [Login as internal provider](#)

**Don't have an account?**  
[Sign up here](#)

# Gå till byggnadssidan

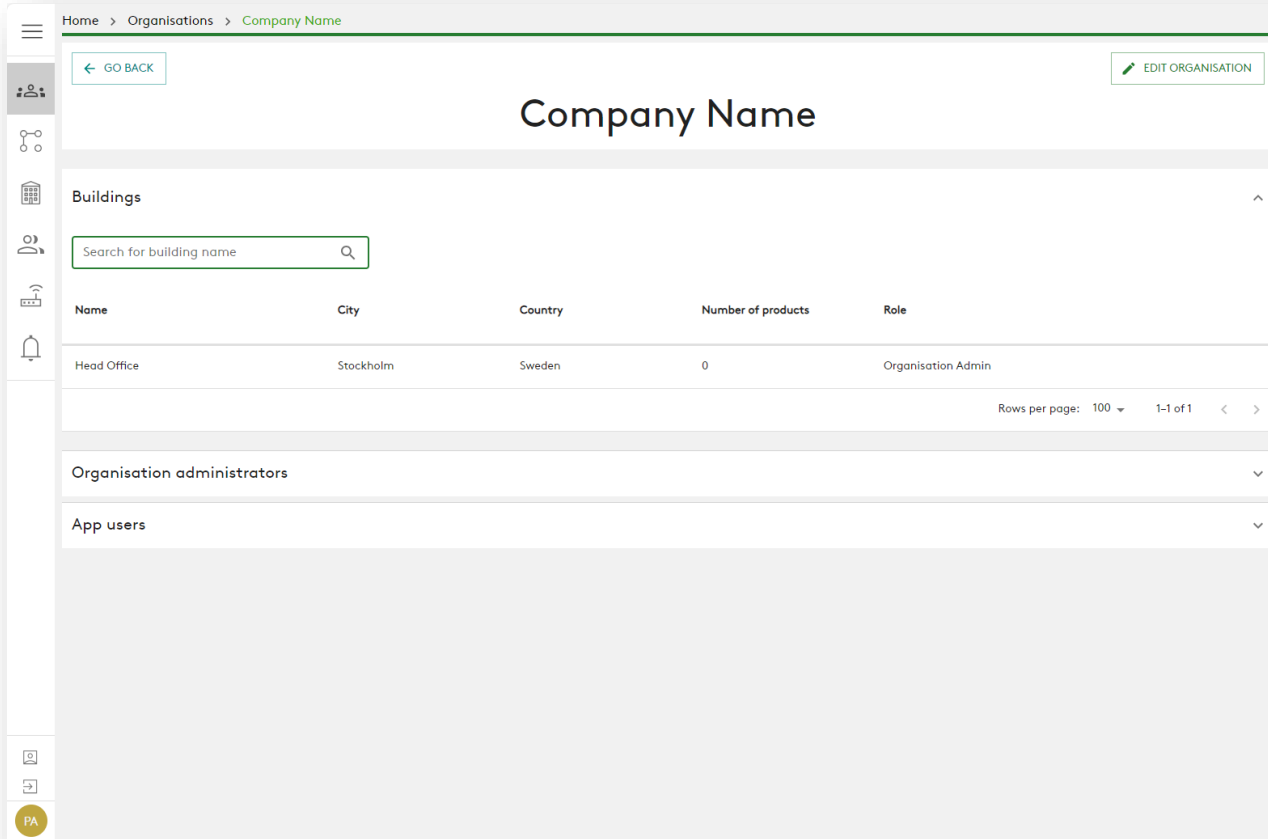

Home > Organisations > Company Name

[← GO BACK](#) [EDIT ORGANISATION](#)

## Company Name

### Buildings

Search for building name

Name	City	Country	Number of products	Role
Head Office	Stockholm	Sweden	0	Organisation Admin

Rows per page: 100 ▾ 1-1 of 1 < >

Organisation administrators ▾

App users ▾

PA

# Lösa in produkten

Home > Buildings > Head Office

← GO BACK

**Head Office**  
Organisation: Company Name

**Products**

Search (name, serial number)

Name ↑	Product type	Building	Serial number	Software version	Active alarm	INSIDE Cloud	INSIDE Connect
There are no products in the building							

Rows per page: 100 ↓ 0-0 of 0 < >

INSIDE Connect routers

Building administrators

Settings

# Produktnamn och produktfamilj

Fyll i:

- produktens namn
- välj produktfamilj
- enhetens serienummer.

Serienumret ska bestå av 8 siffror. Om endast 7 siffror anges på produkten, lägg till en "0" som första siffra.

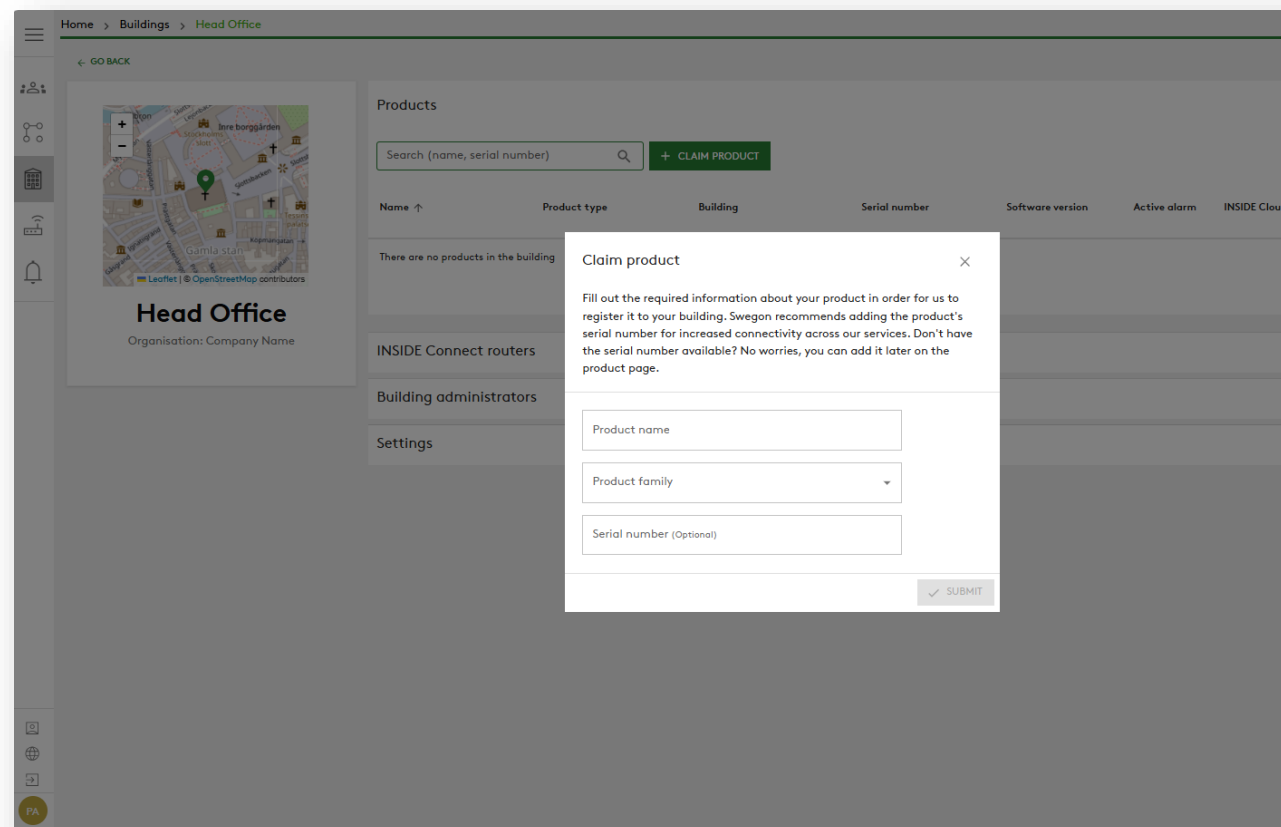

# Är enheten redan ansluten?

Om produkten redan är ansluten behövs endast produktens MAC-adress.

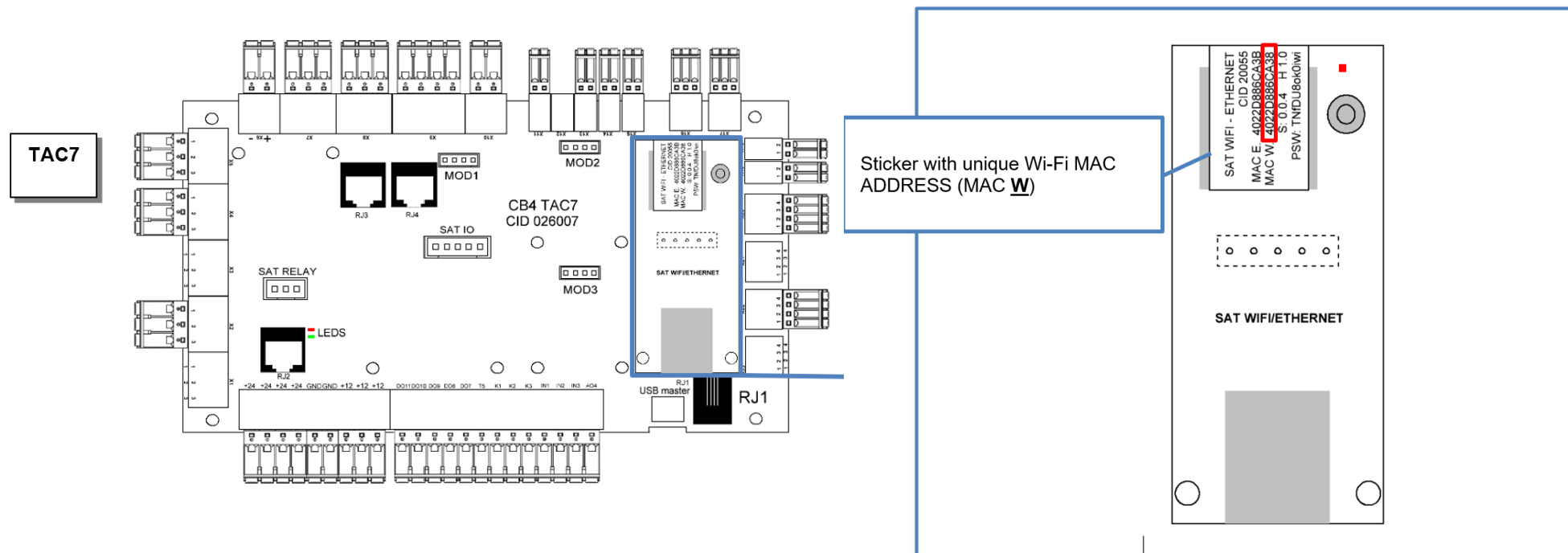

# Hitta MAC-adressen

## Programvaruindikation

Den nödvändiga "W"-MAC-adressen kan hämtas med upptäckningsfunktionen i [TACsimulatorV2](#): Kommunikation → Anslutningsinställningar. Den måste vara ansluten till samma Wi-Fi-nätverk som SAT, utan Ethernet-kabel.

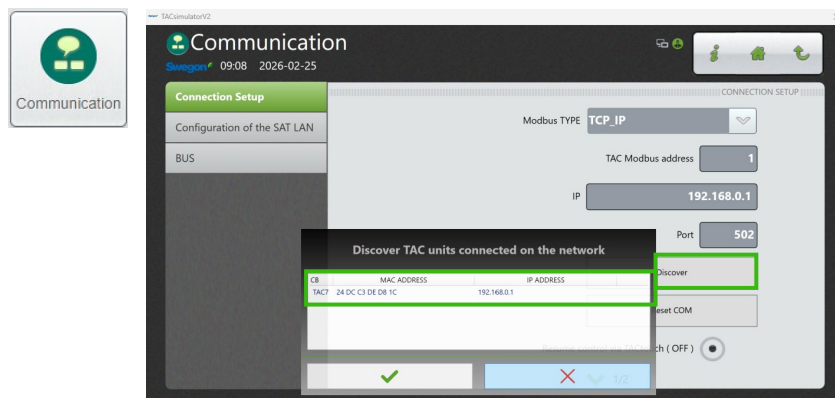

Den nödvändiga "W"-MAC-adressen finns också i standard-SSID för SAT:s Wi-Fi-åtkomstpunkt, innan Wi-Fi konfigureras eller Ethernet-kabeln ansluts.

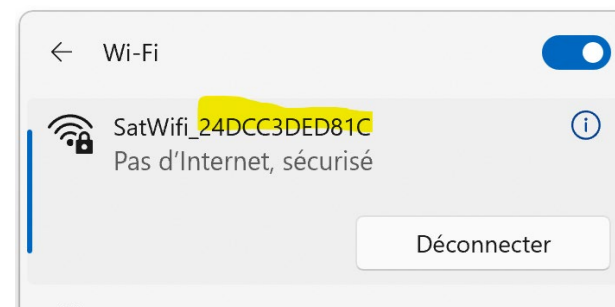

# Produkten har nu lagts till

The screenshot displays the Swegon web interface. The breadcrumb navigation at the top reads "Home > Buildings > Head Office". A sidebar on the left contains navigation icons for home, users, network, buildings, alarms, and notifications. The main content area is titled "Products" and features a search bar with the placeholder "Search (name, serial number)" and a green "+ CLAIM PRODUCT" button. Below the search bar is a table with the following columns: Name, Product type, Building, Serial number, Software version, Active alarm, INSIDE Cloud, and INSIDE Connect. A single product is listed: "GOLD 1" with product type "GOLD ver. F RX/HC" and building "Head Office". The "INSIDE Cloud" column for this product shows a cloud icon and a "CONNECT 30 MIN" button. At the bottom right of the table, it says "Rows per page: 100" and "1-1 of 1". Below the table are four expandable sections: "INSIDE Connect routers", "Building administrators", "Active alarms", and "Settings".

Home > Buildings > Head Office

< GO BACK

**Head Office**  
Organisation: Company Name

**Products**

Search (name, serial number)  + CLAIM PRODUCT

Name ↑	Product type	Building	Serial number	Software version	Active alarm	INSIDE Cloud	INSIDE Connect
GOLD 1	GOLD ver. F RX/HC	Head Office					CONNECT 30 MIN

Rows per page: 100 1-1 of 1

INSIDE Connect routers

Building administrators

Active alarms

Settings

# Felsökning

Om produkten inte är ansluten (röd molnsymbol) ska du kontrollera att:

- Swegon INSIDE är aktiverat på produkten
- INSIDE Ready-certifikatet är giltigt
- Att produktens serienummer är korrekt i INSIDE Portal
- Brandväggsinställningarna och IP-adresserna är korrekta

The screenshot displays the Swegon INSIDE Portal interface. On the left, there is a sidebar with navigation icons and a map view of the 'Head Office' location. The main content area shows a 'Products' table with the following data:

Name ↑	Product type	Building	Serial number	Software version	Active alarm	INSIDE Cloud	INSIDE Connect
GOLD 1	GOLD ver. FRX/HC	Head Office					CONNECT 30 MIN

Below the table, there are several expandable sections: 'INSIDE Connect routers', 'Building administrators', 'Active alarms', and 'Settings'. The 'INSIDE Cloud' column header and the red cloud icon in the first row are highlighted with a green box.

# Om produkten saknar ett giltigt certifikat

Retrofit

# Retrofit – kontrollera programvaruversion

- Programvaruversionen för TAC7 måste vara minst 1.0.11.3.
  - Siffrorna från vänster till höger står för: huvudversion, underversion, revisionsnummer och build-nummer.
- Om du har en äldre programvaruversion, uppgradera. Observera att TACtouch bör använda den senaste versionen av TACsimulatorV2, inklusive den senaste versionen för styrning och HMI.
- Länk till TACsimulatorV2
  - <https://www.swegon.com/globalassets/digital/13657-en-installtacsimulatortac7.zip>
- Uppgraderingsproceduren för TAC7 finns även på Swegons webbplats.

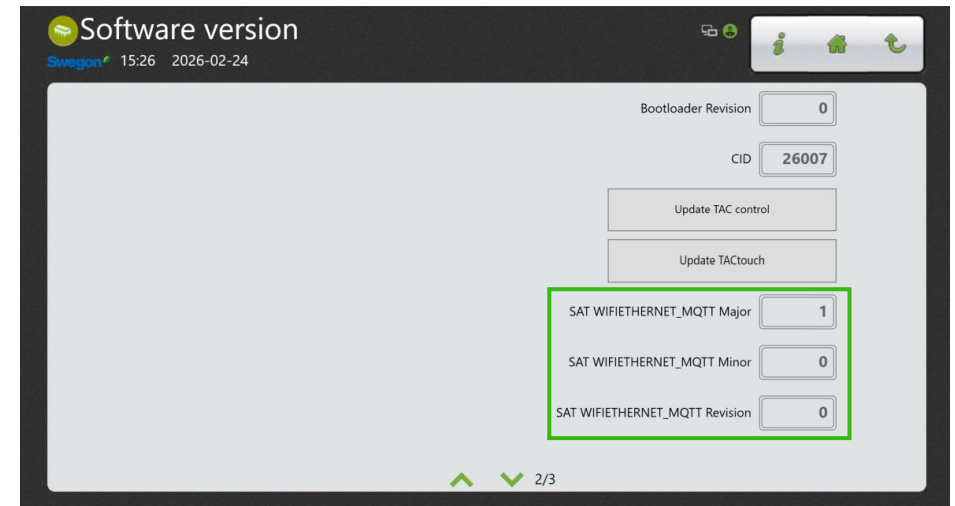
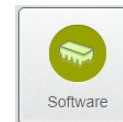

# Retrofit – kontrollera programvaruversion

- Programvaruversionen för SAT INSIDE Ready eller SAT WIFI/ETHERNET måste vara minst 1.0.0.
  - De tre siffrorna står för: huvudversion, underversion och revisionsnummer.
- Om du har en äldre version av SAT-programvaran, konfigurera anslutningen enligt följande och tryck på ”Programuppdatering av SAT COM”.
- Minimiversionen som ska uppgraderas är v 0.0.18.

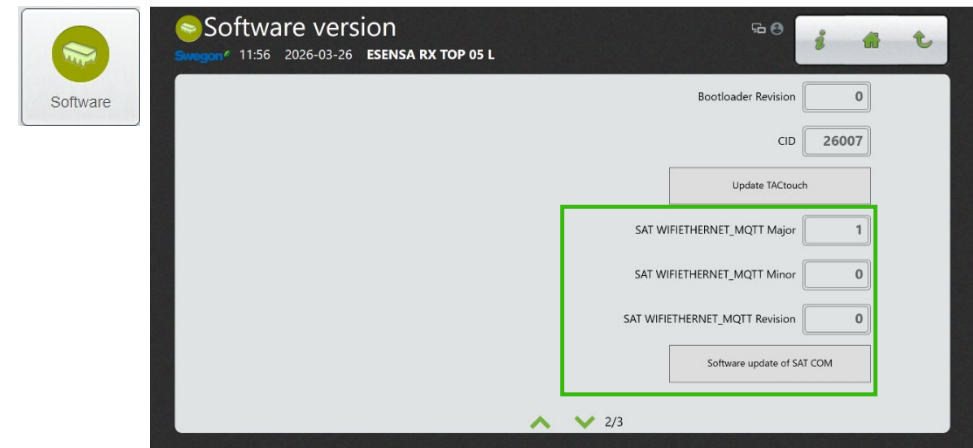

# Retrofit – Inställningar i TACTouch

- Wi-Fi: inga ytterligare inställningar
- Ethernet: Ange ”Kommunikation/  
Konfiguration av SAT LAN”
  - För IP-konfiguration, om det lokala nätverket har funktionen för dynamisk IP-konfiguration, vilket vanligtvis är fallet, välj DHCP
  - I annat fall väljer du Manuell och ser till att följande är korrekt ifyllda: IP-adress, Nätmask, Standardgateway, Primär DNS
  - Tryck på ”Validera” efter konfigurationen

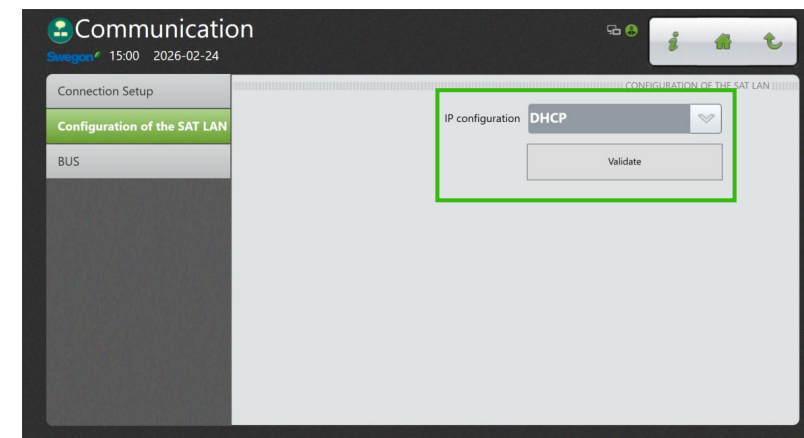
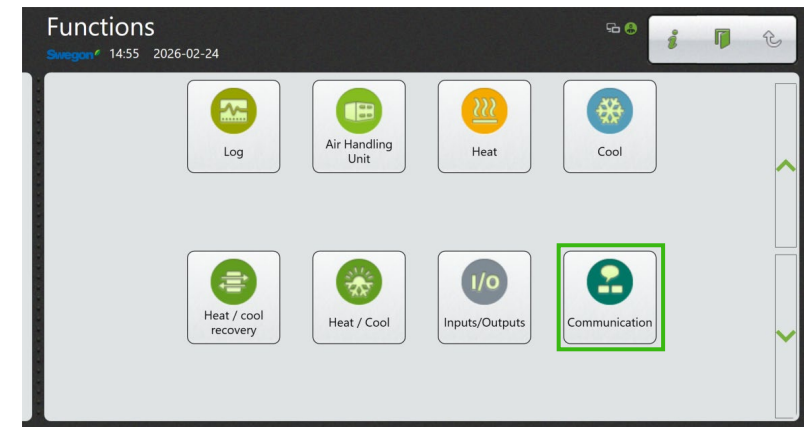
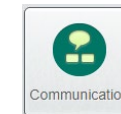

# Gör produkten INSIDE Ready

- Klicka på produkten

The screenshot displays the Swegon INSIDE web interface. The breadcrumb navigation at the top reads 'Home > Buildings > Head Office'. On the left, there is a sidebar with navigation icons and a map view of the 'Head Office' location. The main content area is titled 'Products' and features a search bar with the placeholder text 'Search (name, serial number)' and a '+ CLAIM PRODUCT' button. Below the search bar is a table with the following columns: Name, Product type, Building, Serial number, Software version, Active alarm, INSIDE Cloud, and INSIDE Connect. A single row is visible in the table, with the 'Name' cell containing 'GOLD 1' and a green box highlighting it. The 'Product type' is 'GOLD ver. F.RX/HC', the 'Building' is 'Head Office', and the 'Serial number' is '111111112'. To the right of the serial number is a 'CONNECT 30 MIN' button. Below the table, there are several expandable sections: 'INSIDE Connect routers', 'Building administrators', 'Active alarms', and 'Settings'. The bottom right corner of the interface shows 'Rows per page: 100' and '1-1 of 1'.

Name	Product type	Building	Serial number	Software version	Active alarm	INSIDE Cloud	INSIDE Connect
GOLD 1	GOLD ver. F.RX/HC	Head Office	111111112				CONNECT 30 MIN

# Gör produkten INSIDE Ready

- Klicka på "Make INSIDE Ready"

The screenshot shows a web interface for a Swegon AHU 1 unit. The breadcrumb navigation at the top reads: Home > Buildings > Head Office > Product: GOLD 1. Below this is a navigation bar with a 'GO BACK' button and tabs for Information, Services, Energy reports, Alarms, and Settings. The main content area features a product image of a dark grey AHU unit. Below the image, the unit is identified as 'AHU 1' with a red 'INSIDE Cloud' badge and a serial number 'SN: 111111112'. A prominent green button labeled 'MAKE INSIDE READY' is highlighted with a green border. Below this, there is a section for 'Connected services' showing 'INSIDE Connect' with a 'CONNECT 30 MIN' button. At the bottom, there is a link to 'Learn more about INSIDE Connect here' with an external link icon.

Home > Buildings > Head Office > Product: GOLD 1

← GO BACK

Information Services Energy reports Alarms Settings

Product Metrics  
Current status and metrics for your device.

Software version -  
Serial number 111111112

**AHU 1**

INSIDE Cloud SN: 111111112

**MAKE INSIDE READY**

Connected services

INSIDE Connect

CONNECT 30 MIN

Learn more about INSIDE Connect [here](#)

# Gör produkten klar för INSIDE

- Ange produktens MAC-adress och skicka.

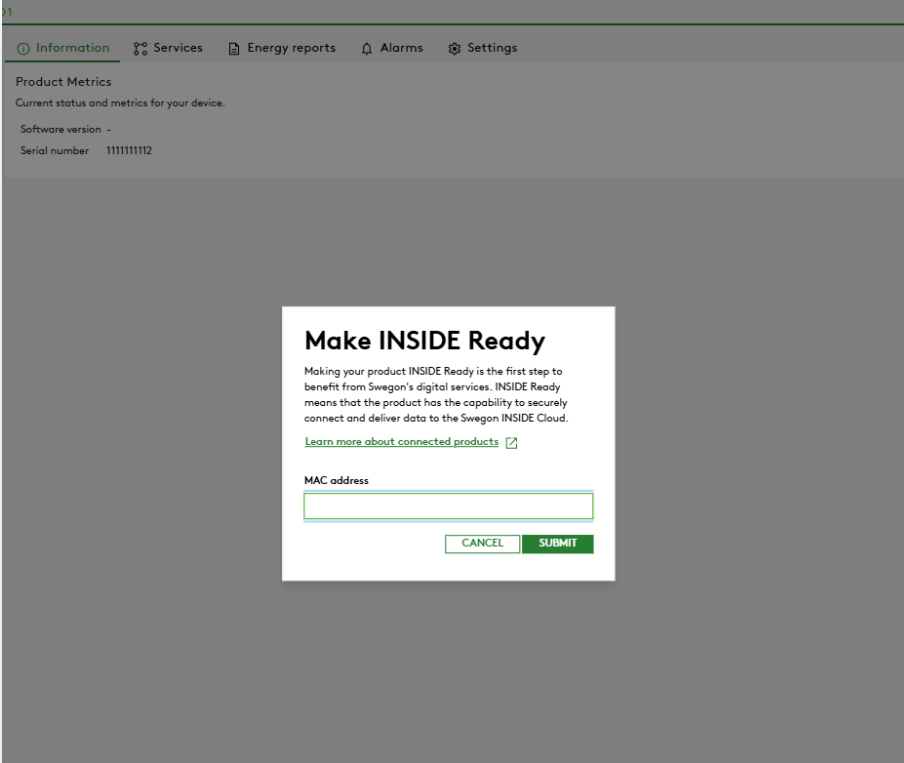

The screenshot shows a web application interface with a navigation bar at the top containing 'Information', 'Services', 'Energy reports', 'Alarms', and 'Settings'. Below the navigation bar, there is a section titled 'Product Metrics' with the subtitle 'Current status and metrics for your device.' Underneath, it displays 'Software version -' and 'Serial number 111111112'. A central modal window titled 'Make INSIDE Ready' is overlaid on the page. The modal contains the following text: 'Making your product INSIDE Ready is the first step to benefit from Swegon's digital services. INSIDE Ready means that the product has the capability to securely connect and deliver data to the Swegon INSIDE Cloud.' Below this text is a link: 'Learn more about connected products' with an external link icon. A text input field labeled 'MAC address' is provided for the user to enter the device's MAC address. At the bottom of the modal, there are two buttons: 'CANCEL' and 'SUBMIT'.

# Förbered produkten för INSIDE

Kopiera ID och aktiveringskod och ange dem i TACsimulatorV2, som du hittar under Funktioner → Programvaruversion. Klicka på "Ladda ner certifikat".

→ Produkten är nu ansluten!

Obs: TACsimulatorV2 måste vara ansluten till samma nätverk som SAT, och SAT måste i sin tur vara ansluten till ett nätverk med internetanslutning

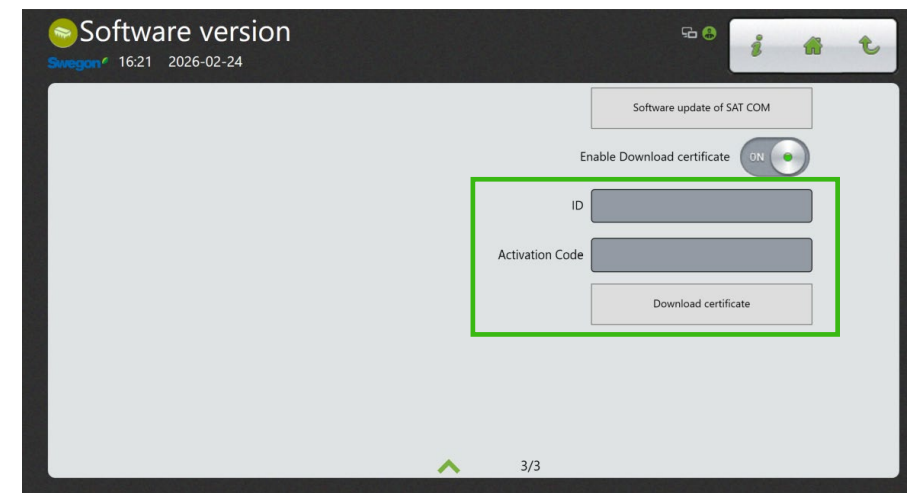
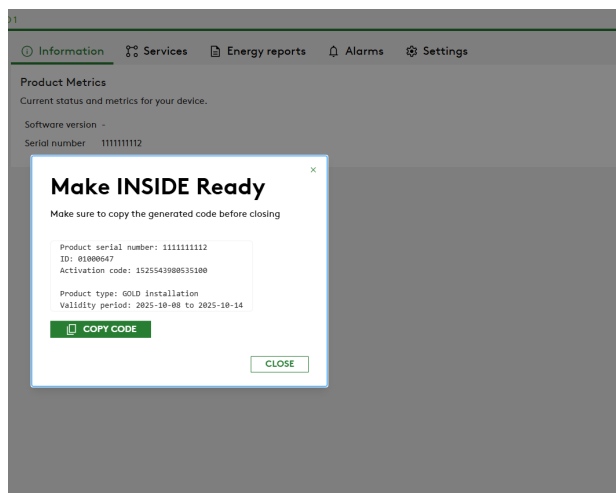

# Gör produkten redo för INSIDE

Anslutning och datadelning indikeras med ett grönt moln

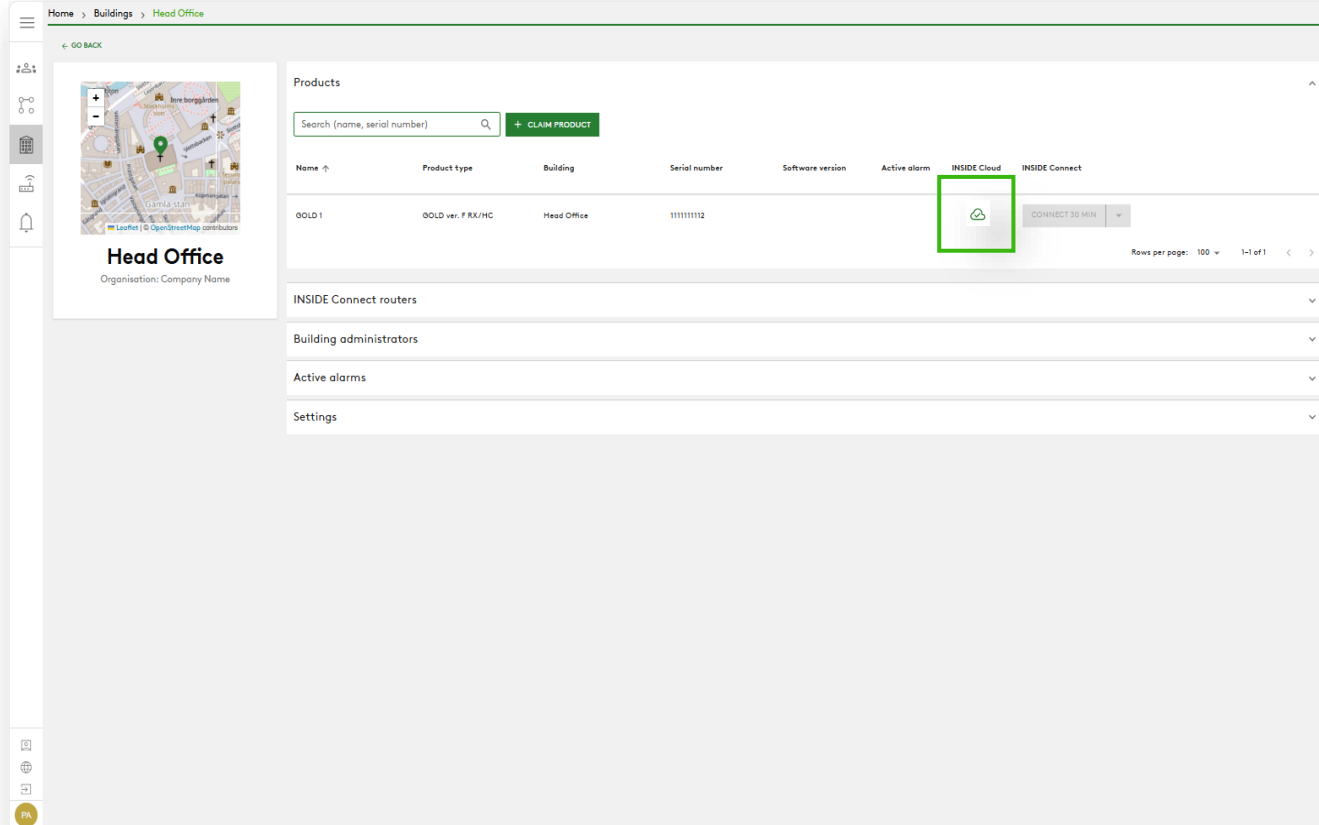

The screenshot displays the Swegon management interface for a building named "Head Office". The interface includes a map on the left and a "Products" table on the right. A green cloud icon in the "INSIDE Cloud" column of the table indicates that the product is ready for connection and data sharing.

Home > Buildings > Head Office

← GO BACK

Map: Head Office  
Organisation: Company Name

Products

Search (name, serial number) [CLAIM PRODUCT]

Name ↑	Product type	Building	Serial number	Software version	Active alarm	INSIDE Cloud	INSIDE Connect
OOLD 1	OOLD ver. F.RX/HC	Head Office	111111112				CONNECT 30 MIN

Rows per page: 100 1-1 of 1

INSIDE Connect routers

Building administrators

Active alarms

Settings



# INSIDE Portal

Möjliggör fjärrövervakning och digitala tjänster

# INSIDE Portal

## – Navet för alla anslutna Swegon-produkter.

Med INSIDE Portal kan du:

- Övervaka viktiga parametrar
  - Status för luftflöde, tryckfall, temperaturer etc.
  - Aktiva larm
- Få djupgående insikter i luftbehandlingsaggregatets prestanda
- Enkelt aktivera tilläggstjänster som kan öka systemets effektivitet
- Bjud in portalanvändare att dela insikter och delegera åtkomstnivå

INSIDE Portal är kostnadsfri

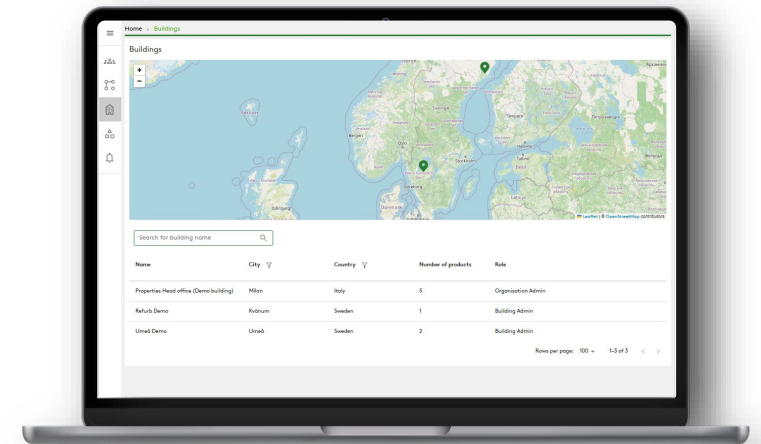

Home > Buildings

### Buildings

Search for building name

Name	City ▾	Country ▾	Number of products	Role
Properties Head office (Demo building)	Milan	Italy	5	Organisation Admin
Refurb Demo	Kvånum	Sweden	1	Building Admin
Umeå Demo	Umeå	Sweden	2	Building Admin

Rows per page: 100 ▾ 1-3 of 3 < >

DU

# INSIDE Portal – övervakning

## Övervakning:

- Driftsstatus
- Nyckelparametrar
- Larm

→ allt live, i realtid

The screenshot displays the Swegon INSIDE Portal interface. The breadcrumb navigation at the top reads: Home > Buildings > Swegon Operations Belgium > Product: PROD OFFICES. The main content area is divided into two columns. The left column features a navigation sidebar with icons for Home, Services, Alarms, and Settings. The main content area shows a 'PROD OFFICES' device card with a photo of the unit, 'INSIDE Cloud' status, SN: 016, and software version 1.0.11. Below the card are 'Connected services' for 'INSIDE Connect' with a 'CONNECT 30 MIN' button and a link to 'INSIDE Manager'. The right column, titled 'Information', contains a 'Product Metrics' section with the following data:

Current status and metrics for your device.	
Software version	1.0.11
Serial number	01626
Last update:	4 min(s) ago
AHU controlled by	MBSCHED
Supply air temp	18.2 °C
Supply air flow	554.0 l/s
Supply air duct pressure	266.0 Pa
Percentage of delta pressure for alarm - Supply filter	0.0 %
Extract air temp	21.3 °C
Extract air flow	553.0 l/s
Extract air duct pressure	224.0 Pa
Percentage of delta pressure for alarm - Extract filter	0.0 %
Outdoor air internal temp	10.0 °C

# INSIDE Portal – larmabonnemang

Larmmeddelanden kan skickas via e-post för anslutna enheter

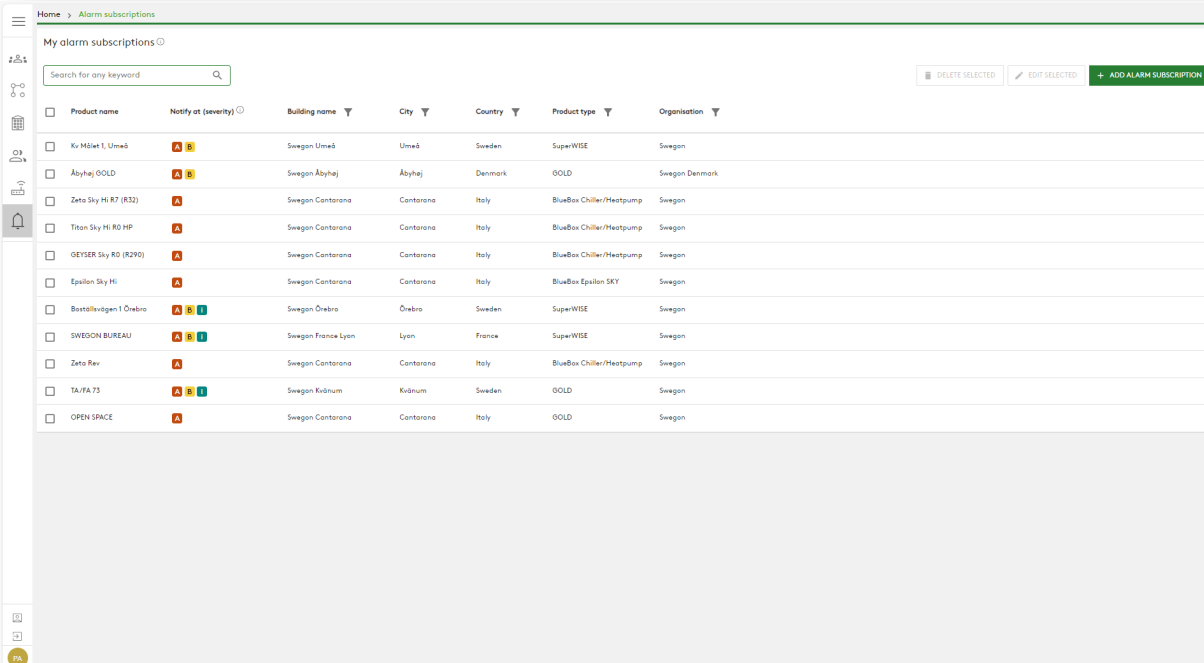

Home > Alarm subscriptions

My alarm subscriptions

Search for any keyword

DELETE SELECTED EDIT SELECTED + ADD ALARM SUBSCRIPTION

<input type="checkbox"/>	Product name	Notify at (severity)	Building name	City	Country	Product type	Organisation
<input type="checkbox"/>	Ki MS&T 1, Umeå	A B	Swegon Umeå	Umeå	Sweden	SuperWISE	Swegon
<input type="checkbox"/>	Åbyhøj GOLD	A B	Swegon Åbyhøj	Åbyhøj	Denmark	GOLD	Swegon Denmark
<input type="checkbox"/>	Zeta Sky HI R7 (R32)	A	Swegon Cantarana	Cantarana	Italy	BlueBox Chiller/Heatpump	Swegon
<input type="checkbox"/>	Titan Sky HI R0 HP	A	Swegon Cantarana	Cantarana	Italy	BlueBox Chiller/Heatpump	Swegon
<input type="checkbox"/>	GEYSER Sky R0 (R290)	A	Swegon Cantarana	Cantarana	Italy	BlueBox Chiller/Heatpump	Swegon
<input type="checkbox"/>	Epsilon Sky HI	A	Swegon Cantarana	Cantarana	Italy	BlueBox Epsilon SKY	Swegon
<input type="checkbox"/>	Basstallvägen 1 Örebro	A B I	Swegon Örebro	Örebro	Sweden	SuperWISE	Swegon
<input type="checkbox"/>	SWEGON BUREAU	A B I	Swegon France Lyon	Lyon	France	SuperWISE	Swegon
<input type="checkbox"/>	Zeta Rev	A	Swegon Cantarana	Cantarana	Italy	BlueBox Chiller/Heatpump	Swegon
<input type="checkbox"/>	TA/FA 73	A B I	Swegon Kårum	Kårum	Sweden	GOLD	Swegon
<input type="checkbox"/>	OPEN SPACE	A	Swegon Cantarana	Cantarana	Italy	GOLD	Swegon

# Larmabonnemang – hur går det till?

Välj larm baserat på produkt, byggnad, stad och andra parametrar

Home > Alarm subscriptions

My alarm subscriptions ○

Search for any keyword

Product name Notify at (severity)

Zeta Sky Hi R7 (R32) A

Titan Sky Hi R0 HP A

OEYSER Sky R0 (R290) A

Epsilon Sky Hi A

Zeta Rev A

OPEN SPACE A

ADD ALARM SUBSCRIPTIONS

Add alarm subscriptions

Product name	Notify at (severity)	Building name	City	Country	Product type	Organisation
Boställsvägen 1 Örebro	A B I	Swegon Örebro	Örebro	Sweden	SuperWISE	Swegon
SWEGON BUREAU	A B I	Swegon France Lyon	Lyon	France	SuperWISE	Swegon
TA/FA 73	A B I	Swegon Krånrum	Krånrum	Sweden	GOLD	Swegon
Åbyhej GOLD	A B I	Swegon Åbyhej	Åbyhej	Denmark	GOLD	Swegon Denmark
Kv Målet 1, Umeå	A B I	Swegon Umeå	Umeå	Sweden	SuperWISE	Swegon
TA12	A B I	Swegon Gothenburg	Gothenburg	Sweden	GOLD	Swegon
GOLD 2005646491	A B I	Swegon Sundsvall	Sundsvall	Sweden	GOLD	Swegon
Swegon - Brandby	A B I	Swegon Brandby	Brandby	Denmark	SuperWISE	Swegon Denmark
Swegon Malmö	A B I	Swegon Malmö	Malmö	Sweden	SuperWISE	Swegon
Swegon Göteborg	A B I	Swegon Gothenburg	Gothenburg	Sweden	SuperWISE	Swegon
LB03 Luleå	A B I	Swegon Luleå	Luleå	Sweden	GOLD	Swegon
GOLD Umeå	A B I	Swegon Umeå	Umeå	Sweden	GOLD	Swegon
Norrkänina kontor	A B I	Swegon Norrköping	Norrköping	Sweden	SuperWISE	Swegon

EDIT SELECTED + ADD ALARM SUBSCRIPTION

SUBMIT

# INSIDE Portal – översikt

Fullständig översikt över alla byggnader inom organisationen

- Byggnadens namn
- Byggnadens läge
- Antal produkter

Buildings

Search for building name

Name	City	Country	Number of products	Role
Properties Head office (Demo building)	Milan	Italy	5	Organisation Admin
Refurb Demo	Kvånum	Sweden	1	Building Admin
Umeå Demo	Umeå	Sweden	2	Building Admin

Rows per page: 100 1-3 of 3

# INSIDE Portal – översikt

Fullständig översikt över Swegons produkter per byggnad

- Plats
- Programvaruversion
- Aktiva larm
- Anslutningsstatus

The screenshot displays the Swegon INSIDE Portal interface. On the left, a map shows the location of Swegon Operations Belgium. The main content area is divided into two sections: a 'Products' table and a sidebar menu.

**Products Table:**

Name	Product type	Building	Serial number	Software version	Active alarm	INSIDE Cloud	INSIDE Connect
PROD OFFICES	GLOBAL (TAC7) PX LP	Swegon Operations Belgium	01626563	1.0.11			CONNECT 30 MIN
TOIT LABO	GLOBAL (TAC7) RX	Swegon Operations Belgium	01627626	1.0.11			CONNECT 30 MIN

Rows per page: 100 | 1-2 of 2

**Sidebar Menu:**

- INSIDE Connect routers
- Building administrators
- Active alarms
- Settings

# INSIDE Portal – inloggning

<https://inside.swegon.com/>

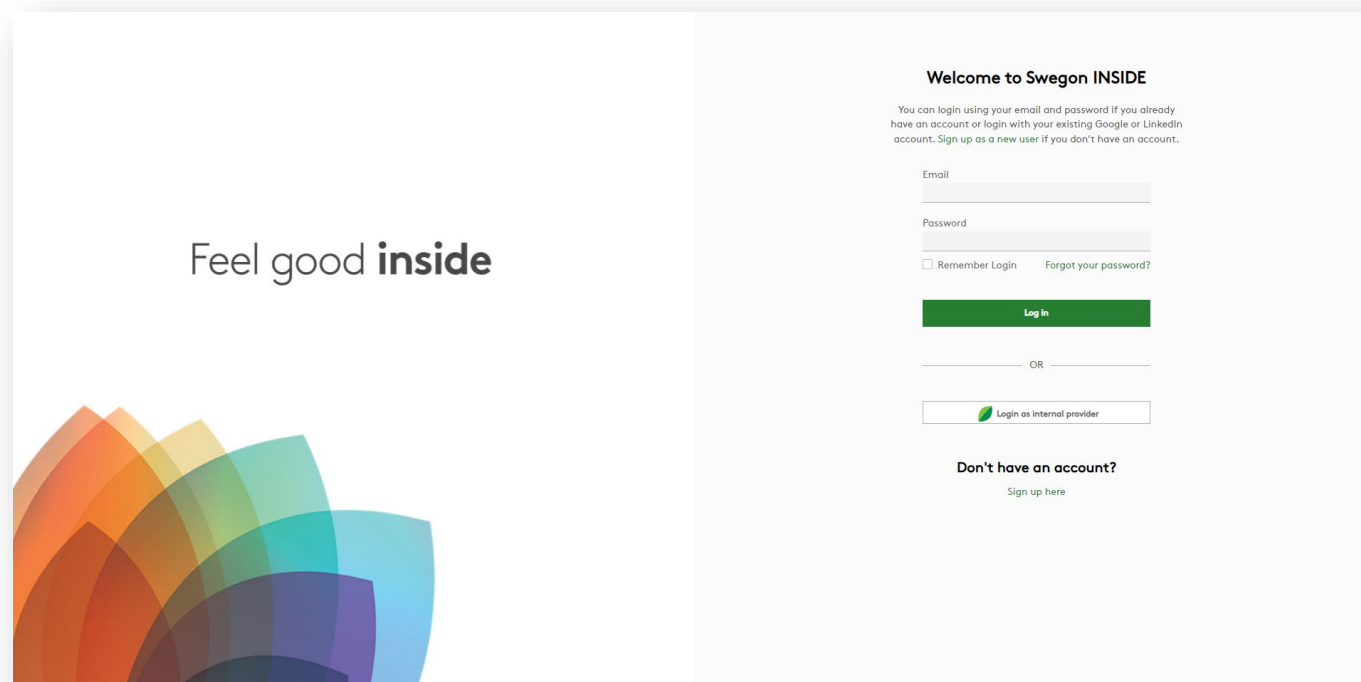

# Sätt att övervaka produkter

## GLOBAL, ESENSA & SERENITY

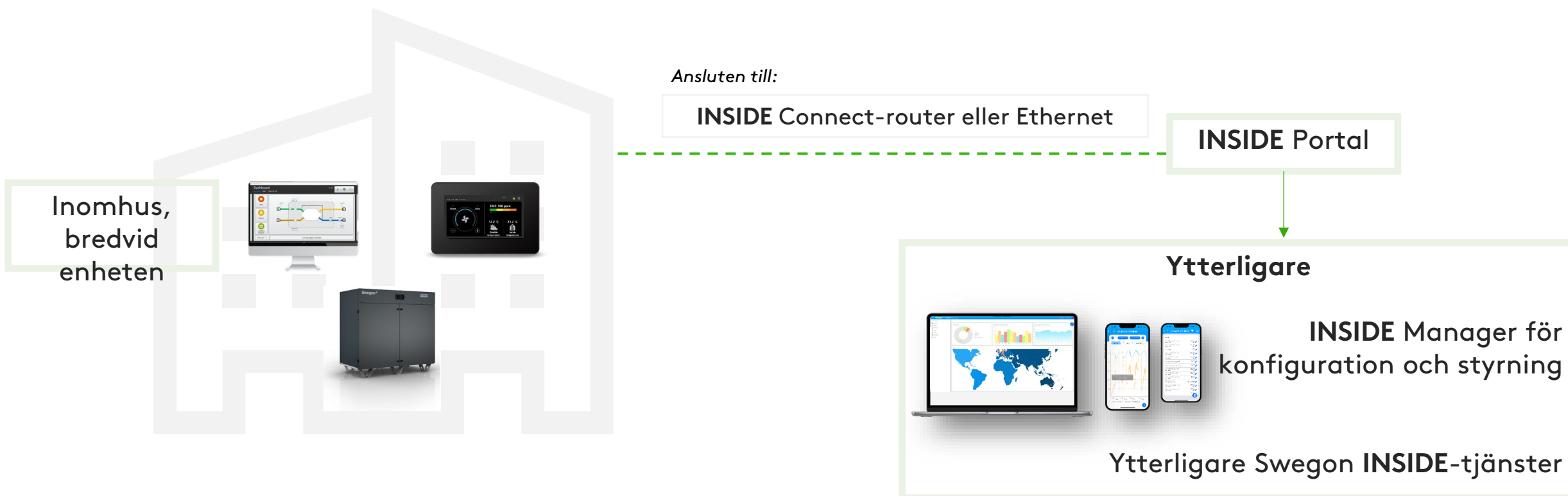

# Digitala tjänster

*Alla system- och sensordata*

**INSIDE Integration**  
Berikar kundernas befintliga byggnadsrelaterade system med data från Swegons produkter.

**INSIDE Analytics & Visualiser**  
Omfattande tjänst för inomhusklimat, rapportering, energiövervakning och användarnöjdhet.

*Hälsosamt inomhusklimat*

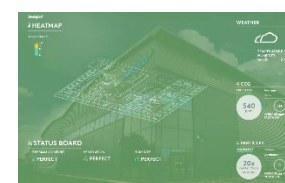
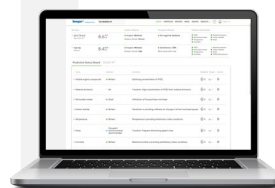

*Förbättra enhetsprestanda*

**INSIDE Portal och INSIDE Manager**  
Möjliggör enhetsöversikt, aktiva larm, fjärrövervakning och fjärrstyrning.

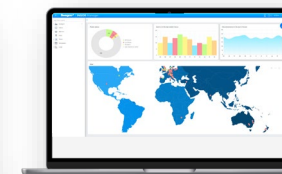



Feel good **inside**