



**Connect
GLOBAL/ESENSA/SERENITY
to Swegon INSIDE**



Which units are **INSIDE Ready**?

GLOBAL/ESENSA/SERENITY

With TAC7 controller

- Must have satellite board “SAT INSIDE Ready”

Retrofit functionality

- All TAC7 controlled AHUs having optional satellite board “SAT WIFI-ETHERNET”, at least v1.0.0



How to connect
GLOBAL/ESENSA/SERENITY units

Connecting GLOBAL, ESENSA or SERENITY

Ethernet connection

Connect one end of the network cable to the facility's existing network and the other to the AHU (SAT INSIDE ready).

Wi-Fi connection

Connect the SAT INSIDE ready to the Wi-Fi network. Easiest is to activate WPS on the local router and press the WPS button on the SAT.

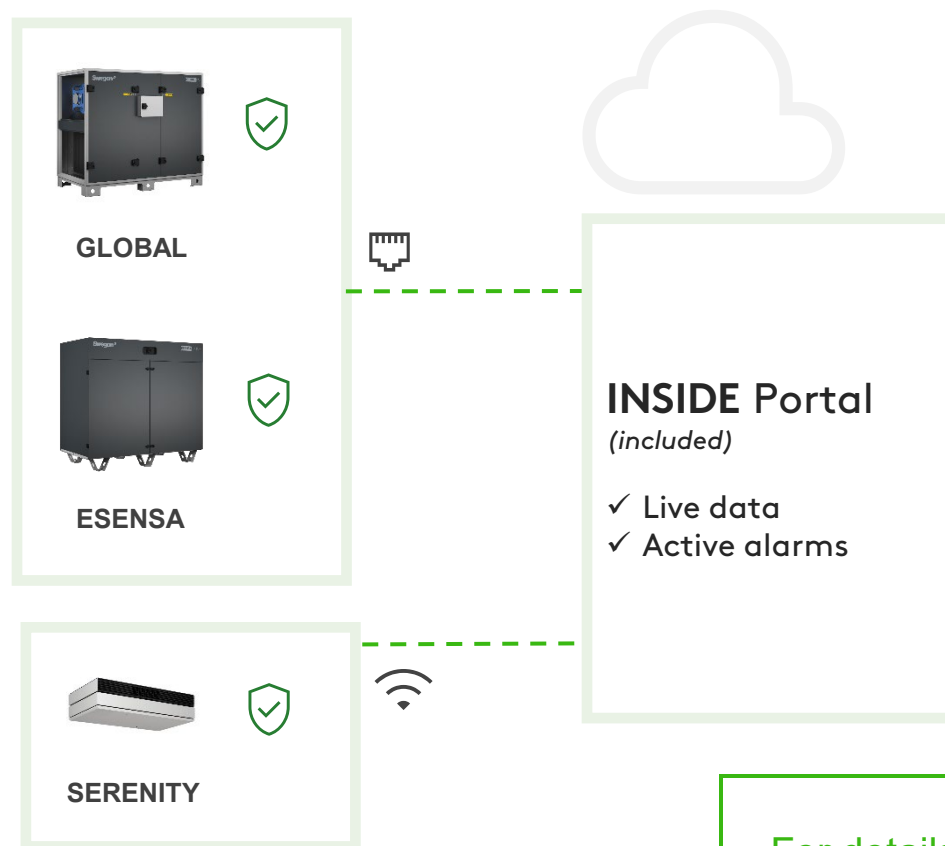

For details, description manual:
TAC7 + MODBUS TCP/IP

Connection settings in TACtouch

- Using Wi-Fi: no additional settings necessary
- Using Ethernet:
 - Find “Communication/Configuration of the SAT LAN”
 - For IP configuration, if the local network has the feature for dynamic IP configuration, which is generally the case, select DHCP
 - Otherwise, select Manual and make sure the following are filled in correctly: IP address, Net mask, Default gateway, Primary DNS
 - Press ”Validate” after the configuration

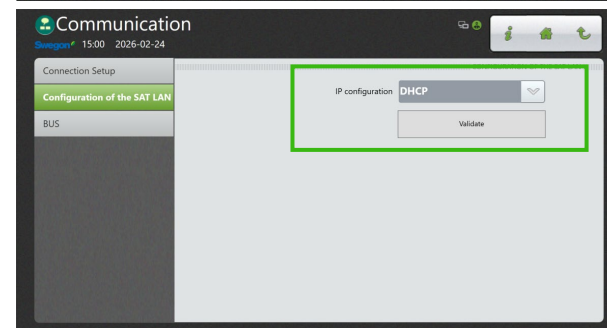
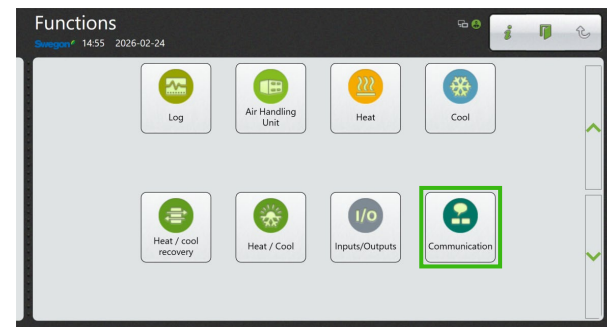
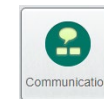

INSIDE Connect – a Swegon router

- Using the Swegon router is an option if the local network cannot be accessed or if there is no local connectivity to the internet. Follow these additional steps:
- After placing the antenna and ensuring a reliable 4G signal of the router, connect it to the SAT using a standard Ethernet cable (RJ45). Be aware, the router must be supplied with +24V DC according to the diagram.
- Configure the IP settings according to the table. Enter Function/Communication/Configuration of SAT LAN

DHCP	Off
IP Address	169.254.235.1
Netmask	255.255.255.248
Default gateway	169.254.235.6
Primary DNS	8.8.8.8

INSIDE Connect – a Swegon router

Wiring

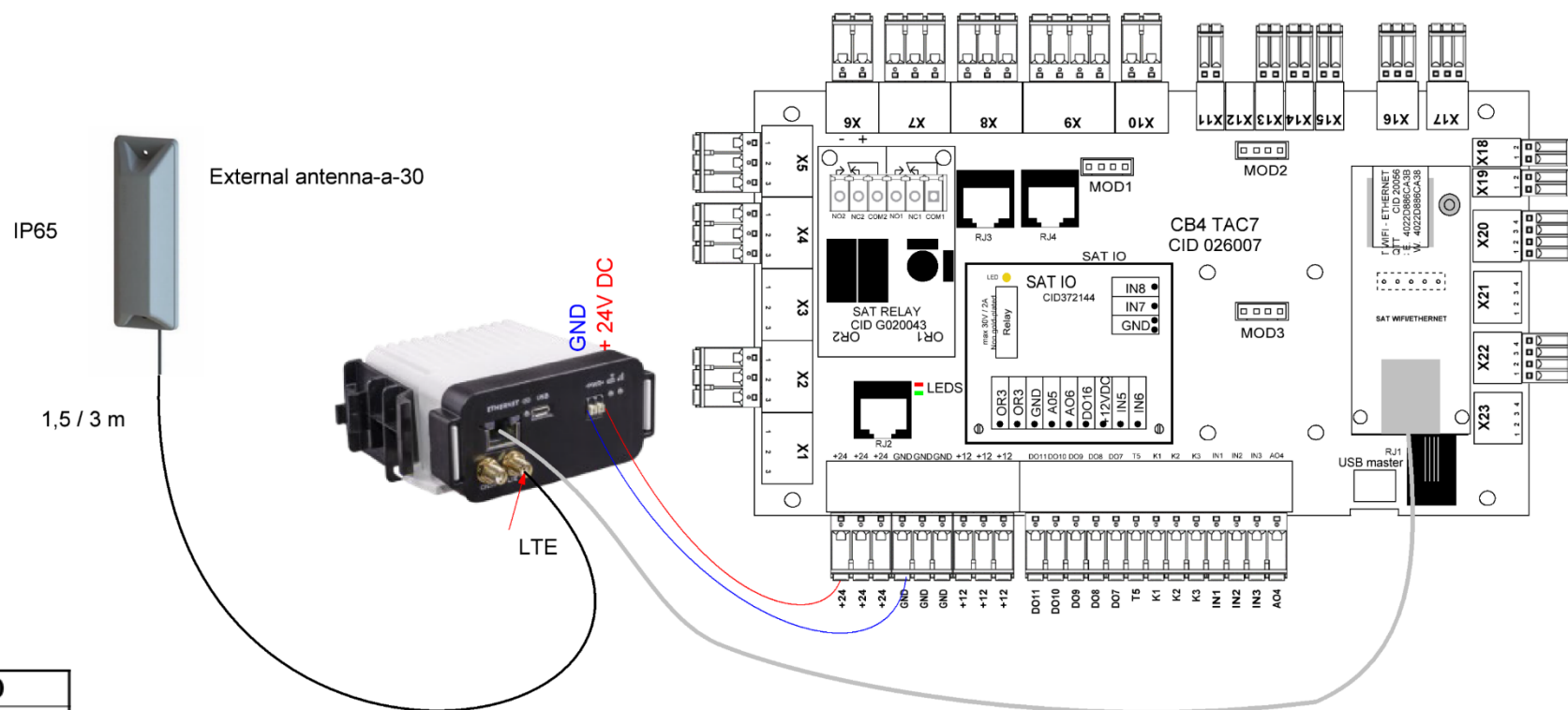

Label	CID
INSIDE Connect, fitted in electrical cabinet	883819
INSIDE Connect, delivered loose (no PSU)	883820
INSIDE External antenna-a-15	883821
INSIDE External antenna-a-30	883822

Create account

- Go to [Swegon website digital services](#)

1. Request access to INSIDE Portal
2. Fill in the form and submit
3. Wait for invitation email

1. Get started!

- 1. Request access to INSIDE Portal
- 2. Claim product/make your product INSIDE Ready (Retrofit only)
- 3. Go to INSIDE Portal

2. Get started!

1. Request access to INSIDE Portal

Enter details below to request a login.

If you already have an account and wish to add a new product or building, please contact digitalservices@swegon.com

Account information

Email (will be used as username)*

First name*

Last name*

Company name*

Building and product information

Choose product*

Serial number of product*

Building name*

Building address*

City*

Country*

Swegon needs the contact information you provide to contact you about the requested service. You may unsubscribe from these communications at anytime. For information on how to unsubscribe, as well as our privacy practices and commitment to protecting your privacy, check out our [Privacy Policy](#).

protected by reCAPTCHA
[Privacy](#) [Terms](#)

SUBMIT

Log into INSIDE Portal

<https://inside.swegon.com>

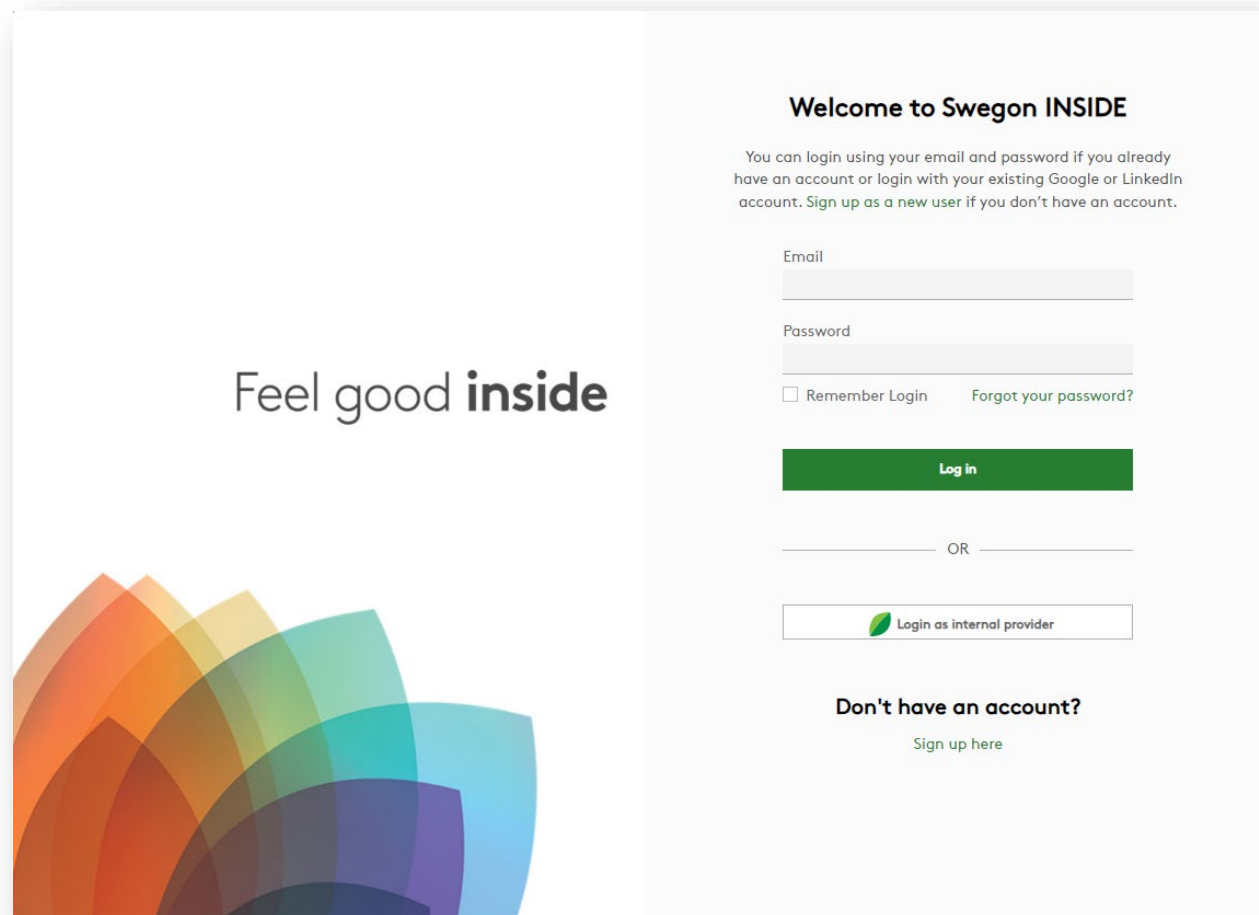

The screenshot shows the Swegon INSIDE login page. On the left, there is a decorative graphic of overlapping semi-circles in various colors (orange, yellow, green, blue, purple) and the text "Feel good inside". On the right, the login form is titled "Welcome to Swegon INSIDE". It includes a brief instruction: "You can login using your email and password if you already have an account or login with your existing Google or LinkedIn account. Sign up as a new user if you don't have an account." Below this are input fields for "Email" and "Password". There are checkboxes for "Remember Login" and "Forgot your password?". A green "Log in" button is positioned below the password field. Below the button is a horizontal line with "OR" in the center. Underneath is a button labeled "Login as internal provider" with a small green leaf icon. At the bottom, there is a section titled "Don't have an account?" with a "Sign up here" link.

Feel good **inside**

Welcome to Swegon INSIDE

You can login using your email and password if you already have an account or login with your existing Google or LinkedIn account. Sign up as a new user if you don't have an account.

Email

Password

Remember Login [Forgot your password?](#)

Log in

OR

 Login as internal provider

Don't have an account?

[Sign up here](#)

Go to building page

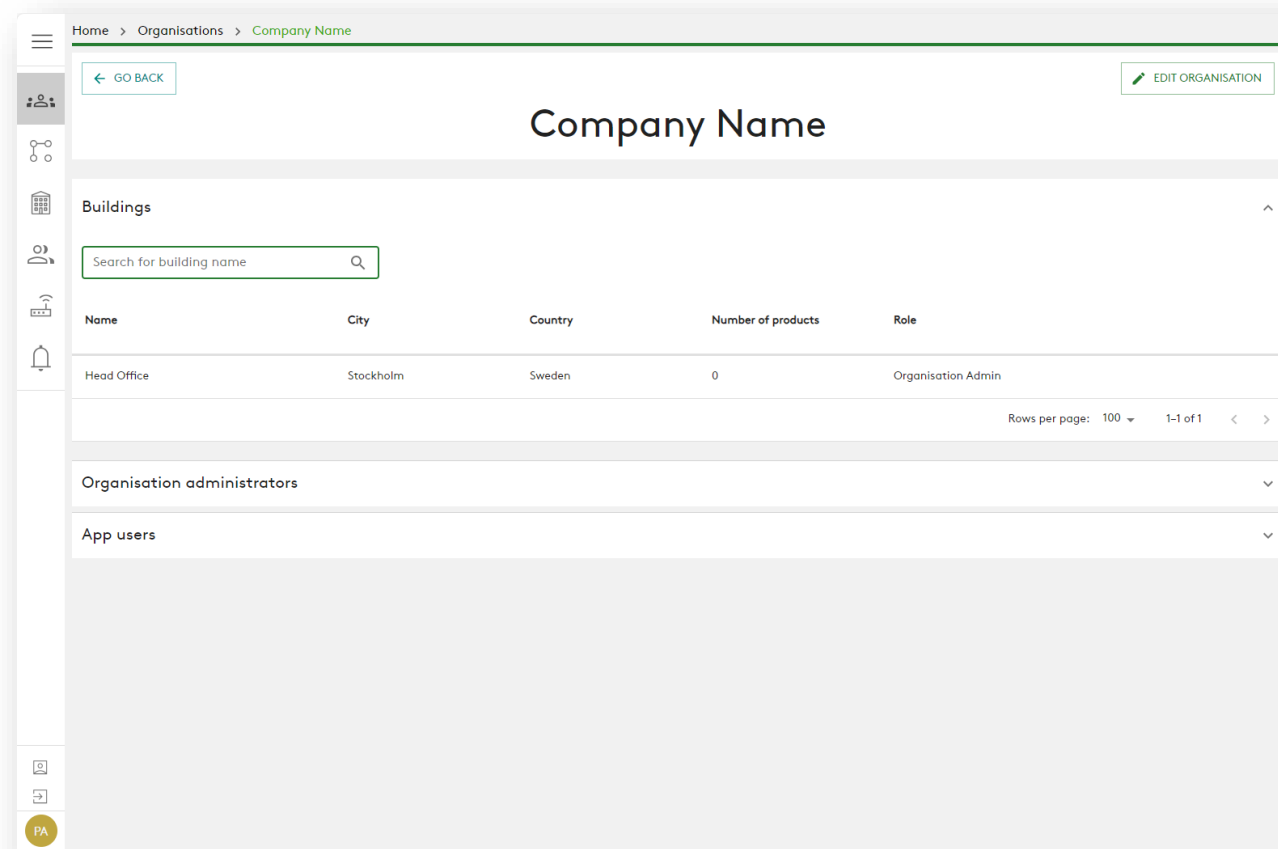

The screenshot shows a web application interface for managing buildings. The breadcrumb navigation at the top reads "Home > Organisations > Company Name". A "GO BACK" button is on the left, and an "EDIT ORGANISATION" button is on the right. The main heading is "Company Name".

The "Buildings" section features a search bar with the placeholder text "Search for building name". Below the search bar is a table with the following data:

Name	City	Country	Number of products	Role
Head Office	Stockholm	Sweden	0	Organisation Admin

At the bottom right of the table, it says "Rows per page: 100" and "1-1 of 1". Below the table are sections for "Organisation administrators" and "App users", both with expandable arrows. A sidebar on the left contains several icons, and a "PA" button is visible at the bottom left.

Claim product

The screenshot displays the Swegon web interface for a building named "Head Office". The breadcrumb navigation at the top reads "Home > Buildings > Head Office". A "GO BACK" link is visible. On the left, a sidebar contains navigation icons for home, users, network, buildings, notifications, and a "PA" button at the bottom. The main content area is divided into two sections:

- Map Section:** A map of the "Head Office" location with a green pin. Below the map, the text reads "Head Office" and "Organisation: Company Name".
- Products Section:** A table titled "Products" with a search bar and a "+ CLAIM PRODUCT" button highlighted with a green box. The table has columns for Name, Product type, Building, Serial number, Software version, Active alarm, INSIDE Cloud, and INSIDE Connect. Below the table, it states "There are no products in the building".

At the bottom right of the products section, there is a pagination control: "Rows per page: 100" and "0-0 of 0". Below the products table are three expandable menu items: "INSIDE Connect routers", "Building administrators", and "Settings".

Product name and family

Name the product, select product family and insert the unit's serial number.

The serial number should contain 8 digits, if only 7 is shown on the product, add a "0" as first digit.

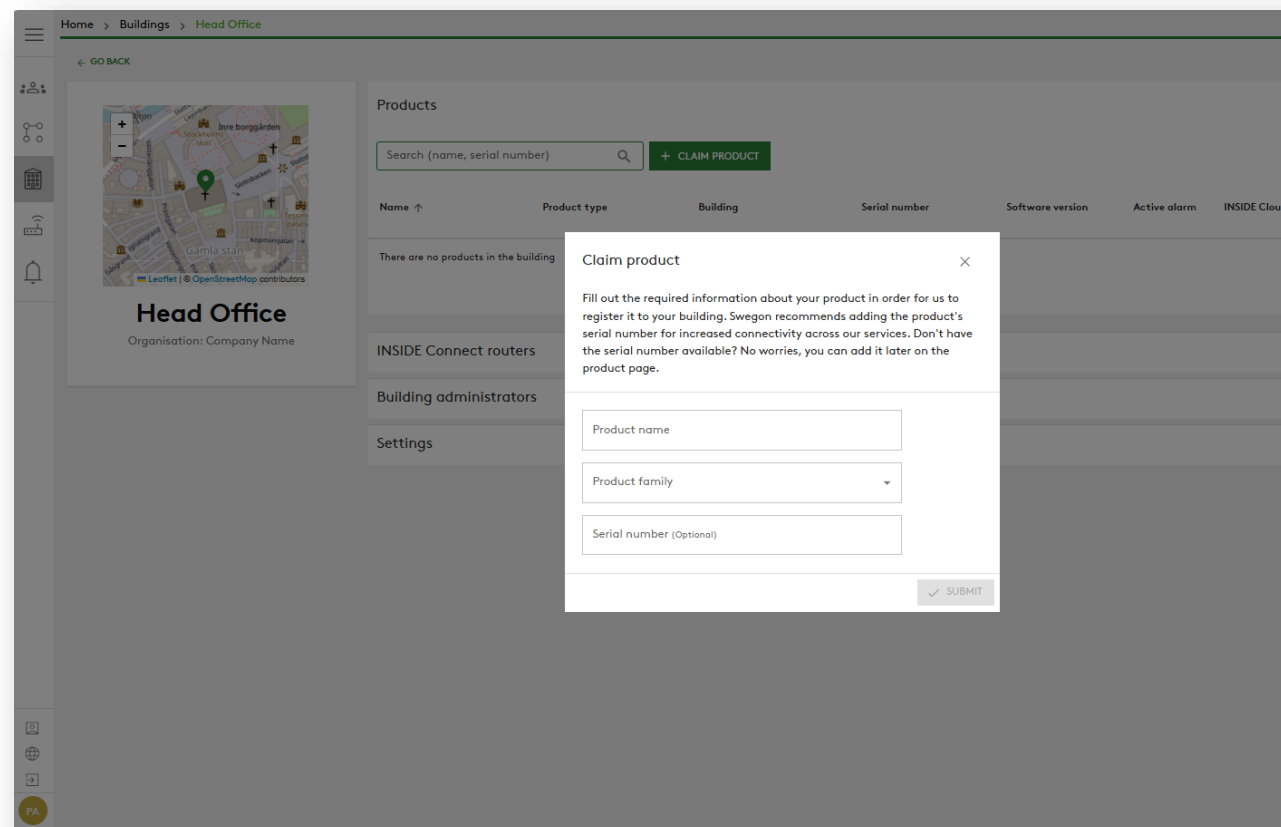

Already connected?

If the product is already connected, the only thing needed is the MAC-address of the product.

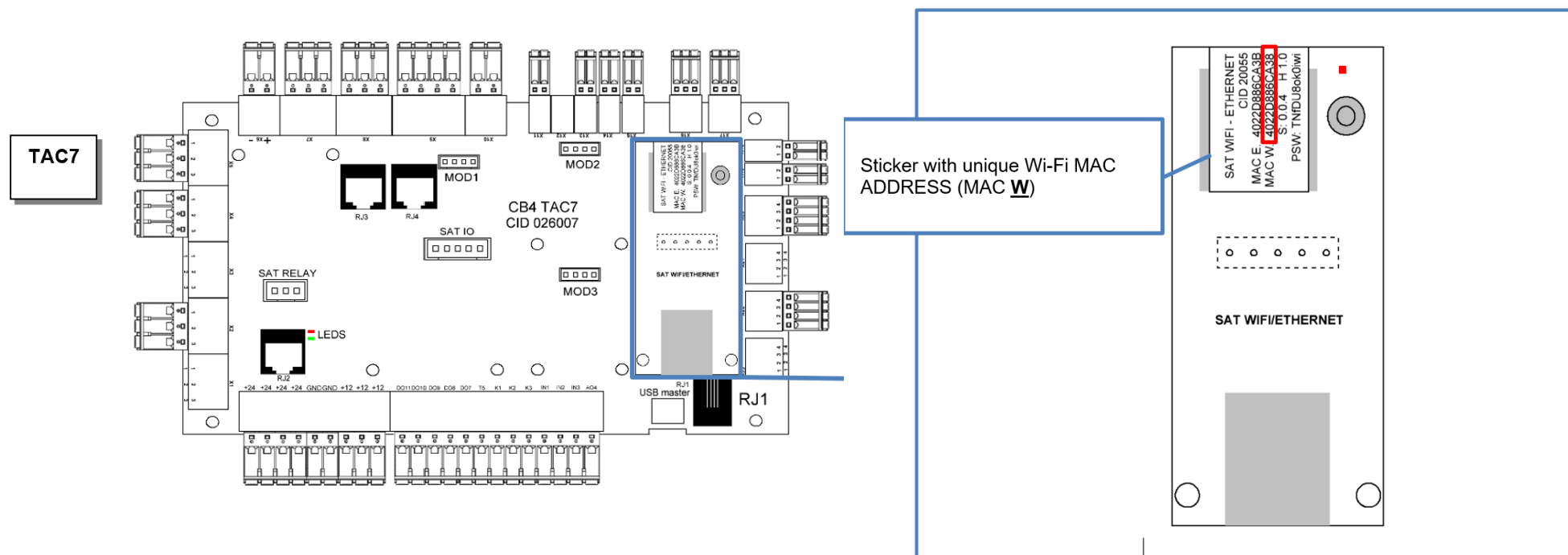

Finding the MAC-address

Software indication

The required 'W' MAC ADDRESS can be retrieved with the discover function, in [TACsimulatorV2](#): Communication → Connection Setup. It must be connected to the same Wi-Fi network as the SAT, without Ethernet cable.

The required 'W' MAC ADDRESS is also available in the default SSID of the SAT Wi-Fi Access Point, prior to configuring the Wi-Fi or connecting the Ethernet cable.

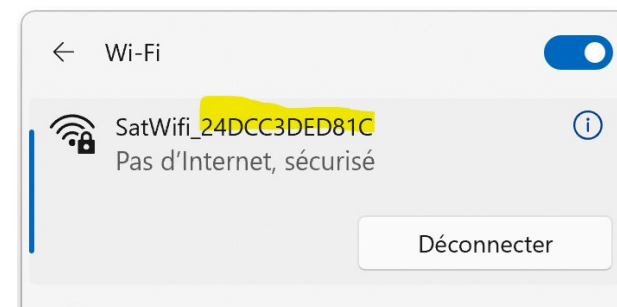
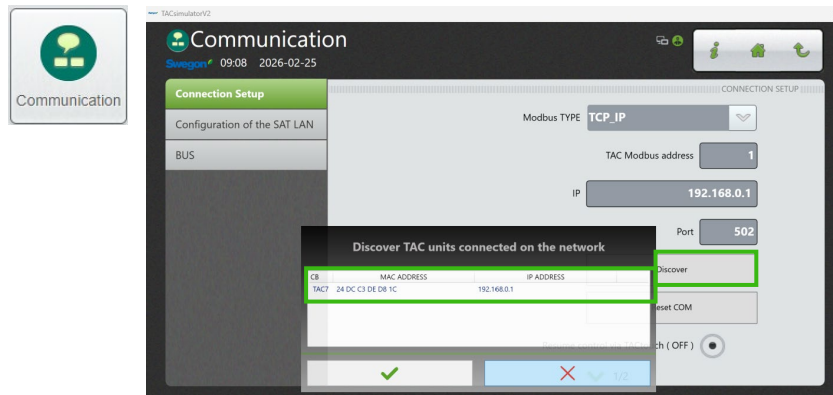

Product successfully claimed

Home > Buildings > Head Office

← GO BACK



Head Office
Organisation: Company Name

Products

Search (name, serial number) [+ CLAIM PRODUCT](#)

Name ↑	Product type	Building	Serial number	Software version	Active alarm	INSIDE Cloud	INSIDE Connect
GOLD 1	GOLD ver. F RX/HC	Head Office					CONNECT 30 MIN <input type="button" value="v"/>

Rows per page: 100 1-1 of 1

- INSIDE Connect routers
- Building administrators
- Active alarms
- Settings

Fault detection

If product is not connected (red cloud symbol) make sure:

- Swegon INSIDE is activated on the product
- The INSIDE Ready certificate is valid
- The product's serial number is correct in INSIDE Portal
- The [firewall settings](#) and IP-addresses are correct

The screenshot displays the Swegon INSIDE Portal interface. On the left, there is a sidebar with navigation icons and a map view of the 'Head Office' location. The main content area shows a 'Products' table with the following data:

Name	Product type	Building	Serial number	Software version	Active alarm	INSIDE Cloud	INSIDE Connect
GOLD1	GOLD ver. FRX/HC	Head Office					CONNECT 30 MIN

Below the table, there are several expandable sections: 'INSIDE Connect routers', 'Building administrators', 'Active alarms', and 'Settings'. The 'INSIDE Cloud' column header and the red cloud icon in the first row are highlighted with a green box.



Product lacks a valid certificate

Retrofit

Retrofit – check software version

- TAC7 software version must be at least 1.0.11.3.
 - Digits from left to right represent: major version, minor version, revision number and build number.
- If an older software version, proceed to upgrade. Note that TACtouch should use latest version of TACsimulatorV2, includes latest version for control and HMI.
- Link for TACsimulatorV2
 - <https://www.swegon.com/globalassets/digital/13657-en-installtacsimulatortac7.zip>
- The upgrade procedure of TAC7 also available on Swegon website.

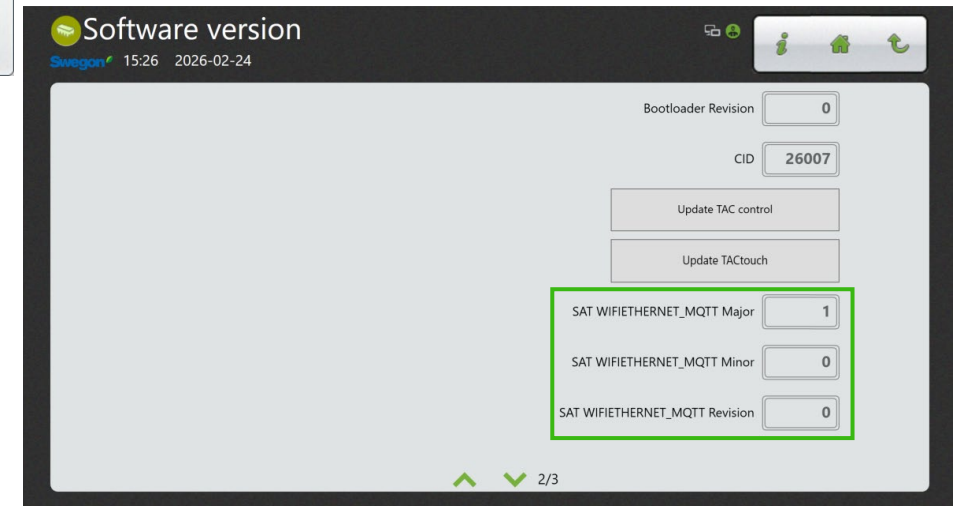
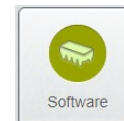

Retrofit – check software version

- SAT INSIDE Ready or SAT WIFI/ETHERNET software version must be at least 1.0.0.
 - The 3 digits represent: major version, minor version and revision number.
- In case of older SAT software version, setup connection as follows and press “Software update of SAT COM”.
- The minimum version to be upgraded is v 0.0.18.

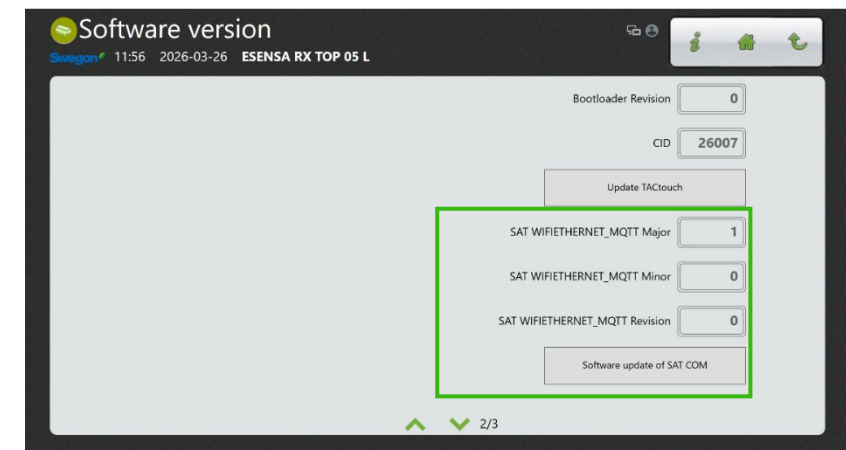
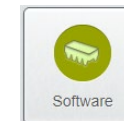

Retrofit - Connection settings in TACTouch

- Wi-Fi: no additional settings
- Ethernet: Enter “Communication/ Configuration of the SAT LAN”
 - For IP configuration, if the local network has the feature for dynamic IP configuration, which is generally the case, select DHCP
 - Otherwise, select Manual and make sure the following are filled in correctly: IP address, Net mask, Default gateway, Primary DNS
 - Press “Validate” after the configuration

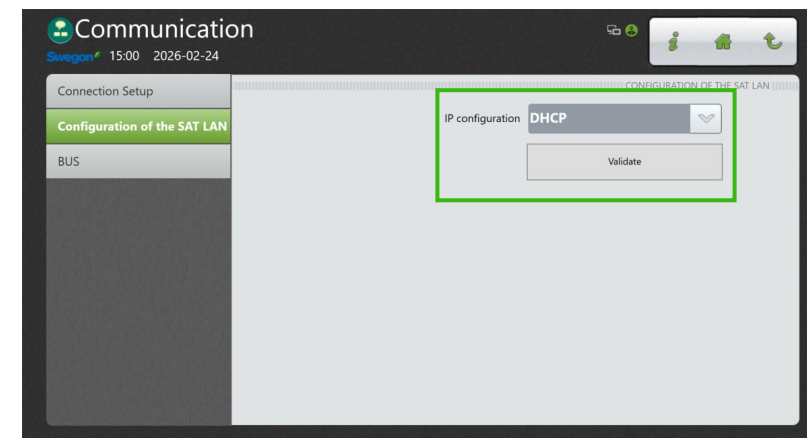
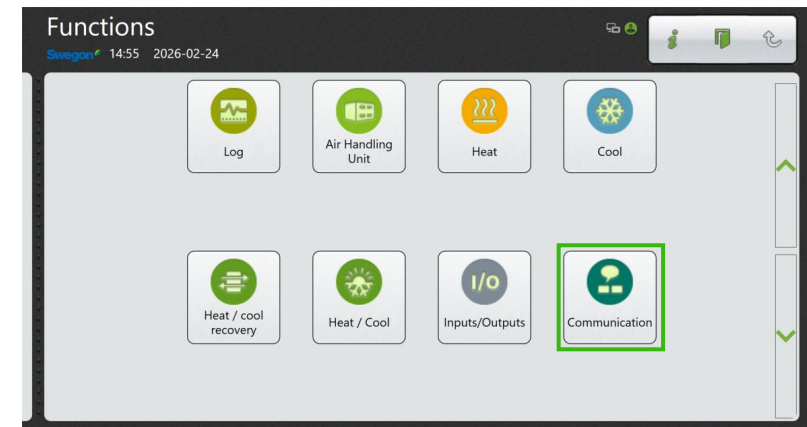
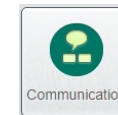

Make product INSIDE Ready

- Click on the product

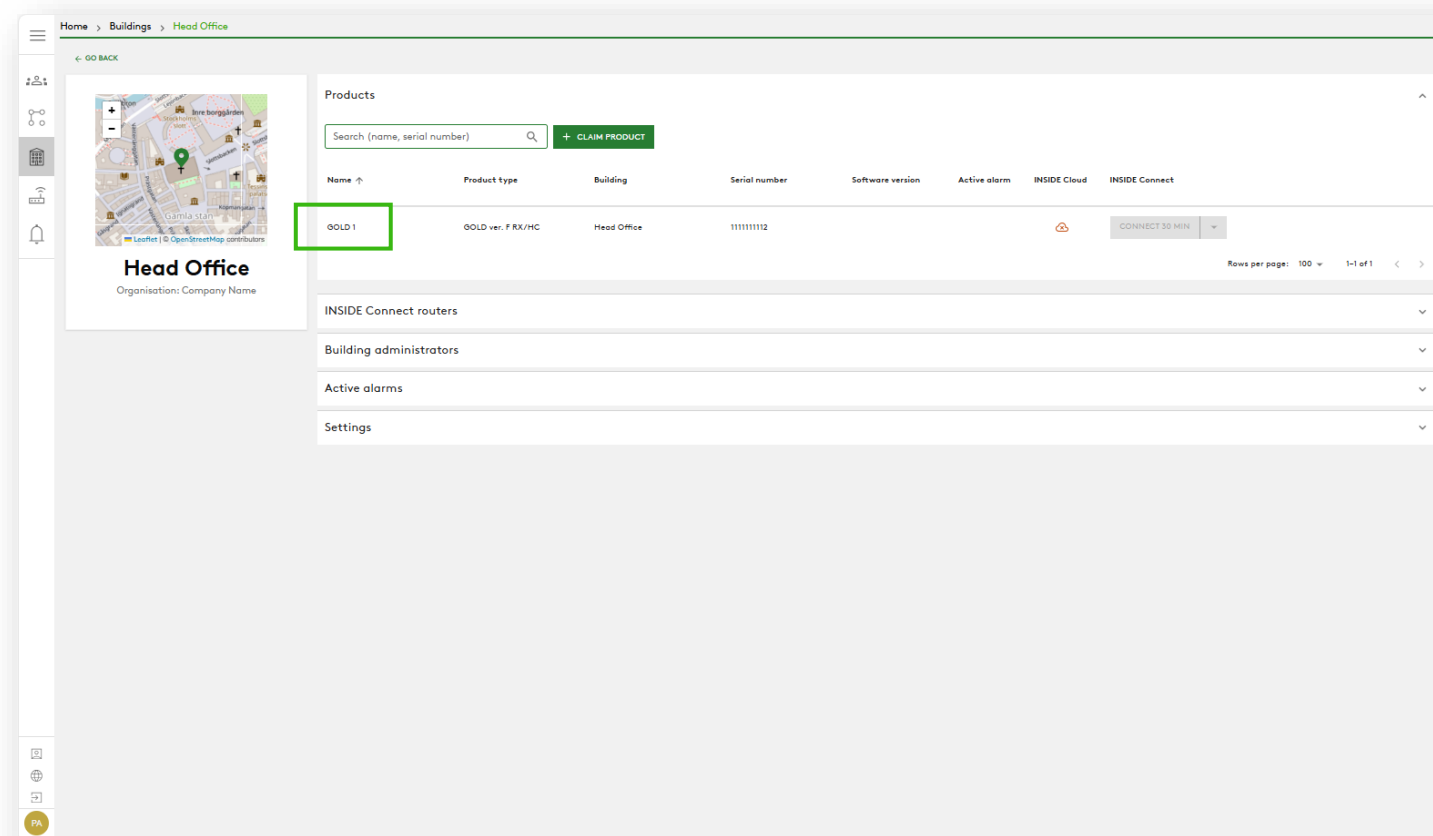

The screenshot displays the Swegon web interface for a building named 'Head Office'. The interface includes a navigation menu on the left, a breadcrumb trail at the top, and a main content area. The main content area features a map of the building location, a search bar for products, and a table of product details. A green box highlights the 'GOLD 1' product in the table. Below the table, there are several expandable sections for 'INSIDE Connect routers', 'Building administrators', 'Active alarms', and 'Settings'.

Home > Buildings > Head Office

GO BACK

Head Office
Organisation: Company Name

Products

Search (name, serial number) + CLAIM PRODUCT

Name	Product type	Building	Serial number	Software version	Active alarm	INSIDE Cloud	INSIDE Connect
GOLD 1	GOLD ver. F.RX/HC	Head Office	111111112				CONNECT 30 MIN

Rows per page: 100 1-1 of 1

INSIDE Connect routers

Building administrators

Active alarms

Settings

Make product INSIDE Ready

- Click “Make INSIDE Ready”

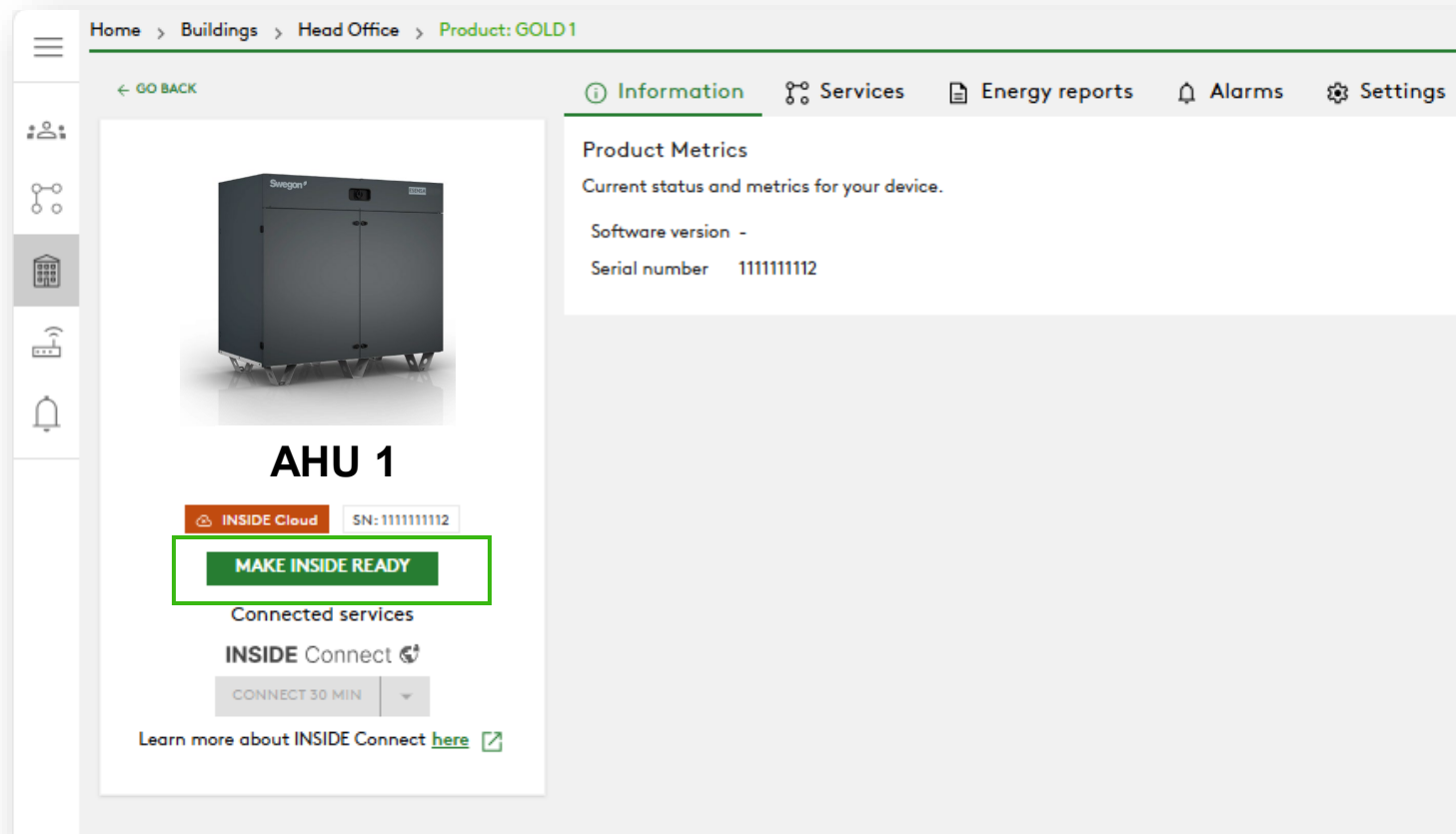

The screenshot shows a web interface for managing a Swegon product. The breadcrumb navigation at the top reads: Home > Buildings > Head Office > Product: GOLD 1. Below this is a navigation bar with a 'GO BACK' link and tabs for Information, Services, Energy reports, Alarms, and Settings. The main content area features a product image of a dark grey AHU unit. Below the image, the unit is identified as 'AHU 1' with a status of 'INSIDE Cloud' and a serial number of 'SN: 111111112'. A prominent green button labeled 'MAKE INSIDE READY' is highlighted with a green border. Below this, there is a section for 'Connected services' showing 'INSIDE Connect' with a 'CONNECT 30 MIN' button. At the bottom, a link says 'Learn more about INSIDE Connect here' with an external link icon.

Make product INSIDE Ready

- Enter the product's MAC address and submit.

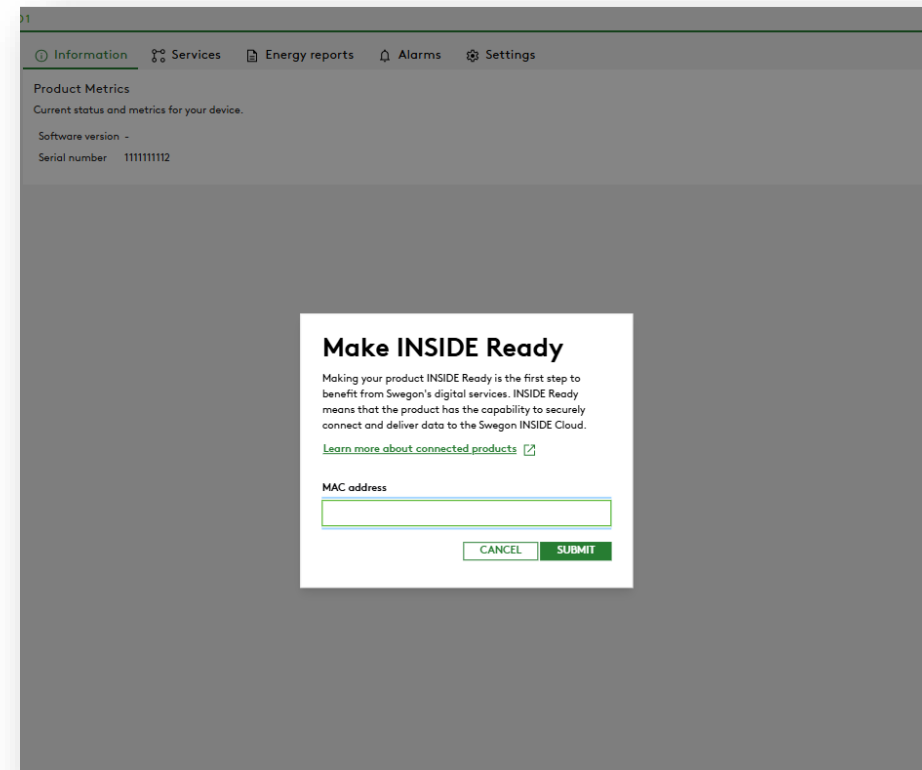

The screenshot shows a web application interface with a navigation bar at the top containing 'Information', 'Services', 'Energy reports', 'Alarms', and 'Settings'. Below the navigation bar, there is a 'Product Metrics' section with the text 'Current status and metrics for your device.' and two rows of data: 'Software version -' and 'Serial number 111111112'. A modal dialog box is centered on the screen with the title 'Make INSIDE Ready'. The dialog contains the following text: 'Making your product INSIDE Ready is the first step to benefit from Swegon's digital services. INSIDE Ready means that the product has the capability to securely connect and deliver data to the Swegon INSIDE Cloud.' Below this text is a link: '[Learn more about connected products](#)'. A text input field labeled 'MAC address' is positioned below the link. At the bottom of the dialog are two buttons: 'CANCEL' and 'SUBMIT'.

Make product INSIDE Ready

Copy ID and Activation code and enter in TACsimulatorV2, found in Functions → Software version click “Download Certificate”.

→ Product successfully connected!

N.B.: TACsimulatorV2 must be connected to the same network of the SAT and the SAT, in turn, must be connected to a network having internet connectivity

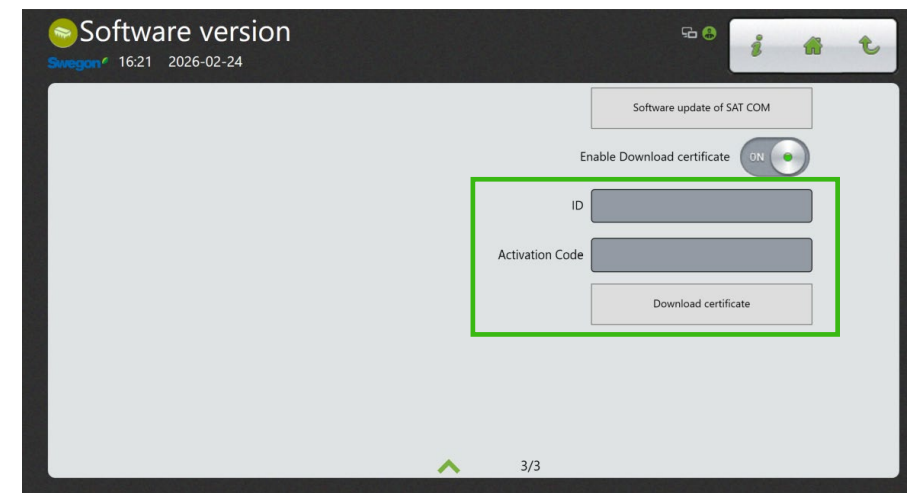
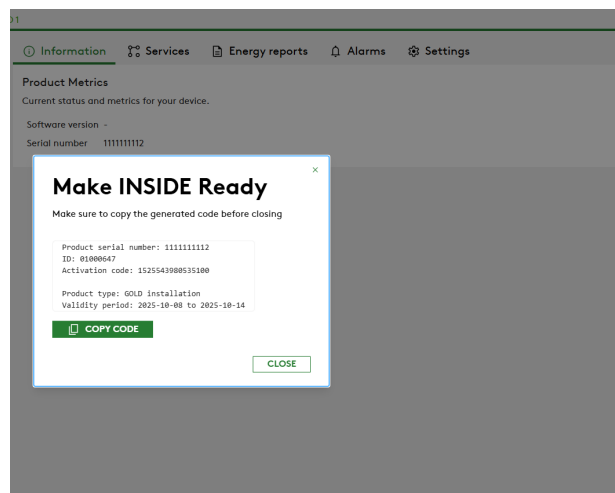

Make product INSIDE Ready

Connectivity and data sharing is indicated with a green cloud

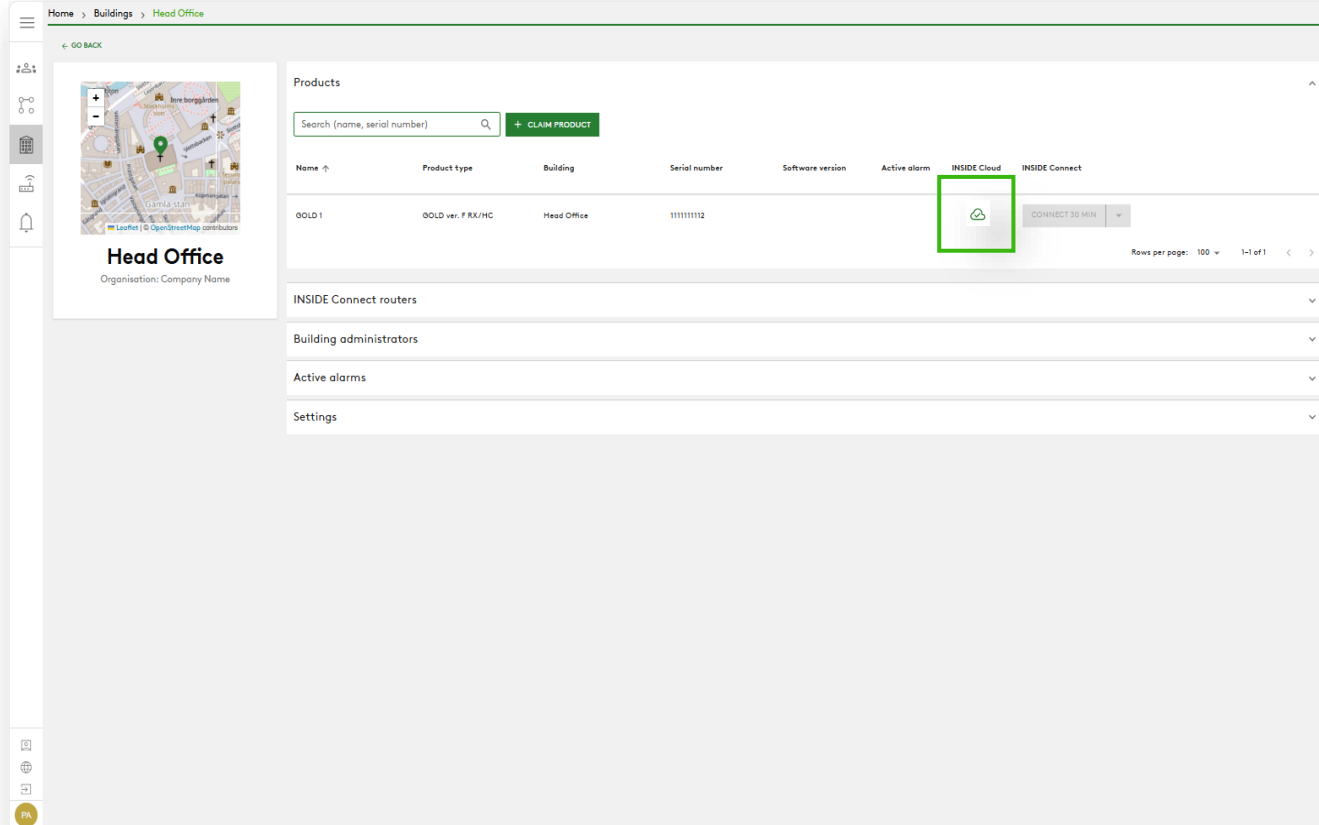

The screenshot displays the Swegon management interface for a building named "Head Office". The interface includes a sidebar with navigation icons, a breadcrumb trail (Home > Buildings > Head Office), and a "GO BACK" button. A map of the building location is shown on the left. The main content area features a "Products" section with a search bar and a "+ CLAIM PRODUCT" button. Below this is a table with the following columns: Name, Product type, Building, Serial number, Software version, Active alarm, INSIDE Cloud, and INSIDE Connect. A single product is listed with the name "OOLD 1", product type "OOLD ver. F.RX/HC", building "Head Office", and serial number "111111112". The "INSIDE Cloud" column for this product contains a green cloud icon, which is highlighted by a green square. The "INSIDE Connect" column contains a "CONNECT 30 MIN" button. Below the table are several expandable sections: "INSIDE Connect routers", "Building administrators", "Active alarms", and "Settings". The bottom right corner shows "Rows per page: 100" and "1-1 of 1".

Name	Product type	Building	Serial number	Software version	Active alarm	INSIDE Cloud	INSIDE Connect
OOLD 1	OOLD ver. F.RX/HC	Head Office	111111112				CONNECT 30 MIN



INSIDE Portal

Enables remote monitoring and digital services

INSIDE Portal

– The hub for all connected Swegon products.

INSIDE Portal allows you to:

- Monitor key parameters
 - Status of air flow, pressure drop, temperatures etc.
 - Active alarms
- Gain high level insights into the AHU performance
- Easily activate additional services that can increase the efficiency of your system
- Invite portal users to share insight and delegate level of access

INSIDE Portal is free of charge

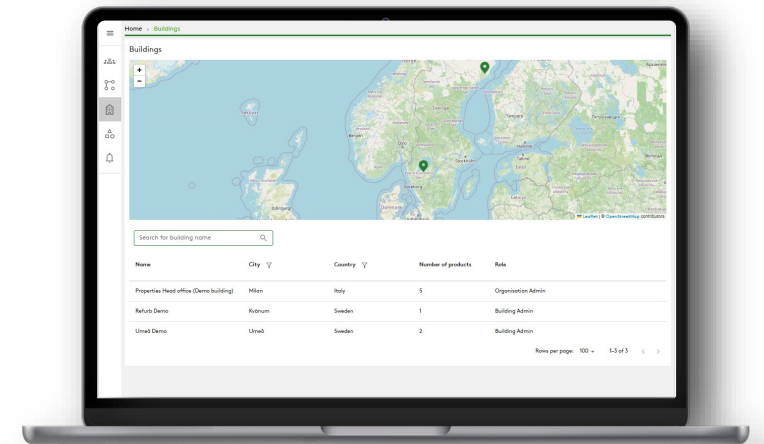

Home > Buildings

Buildings

Search for building name

Name	City ▾	Country ▾	Number of products	Role
Properties Head office (Demo building)	Milan	Italy	5	Organisation Admin
Refurb Demo	Kvånum	Sweden	1	Building Admin
Umeå Demo	Umeå	Sweden	2	Building Admin

Rows per page: 100 ▾ 1-3 of 3 < >

DU

INSIDE Portal - monitoring

Monitor:

- Operational status
- Key parameters
- Alarms

→ all live, in real time

The screenshot displays the Swegon INSIDE Portal monitoring interface. The breadcrumb navigation at the top reads: Home > Buildings > Swegon Operations Belgium > Product: PROD OFFICES. The main content area is divided into two columns. The left column features a navigation sidebar with icons for users, services, home, lock, person, and alarm. The central panel shows a product image of a black Swegon AHU unit, the title 'PROD OFFICES', and details: 'INSIDE Cloud' with 'SN: 016' and 'Software version: 1.0.11'. Below this, there is a 'Connected services' section with 'INSIDE Connect' and a 'CONNECT 30 MIN' button. A link to 'Learn more about INSIDE Connect here' and 'INSIDE Manager' are also present. The right column, titled 'Information', contains a 'Product Metrics' section with the text 'Current status and metrics for your device.' and a list of key parameters:

Software version	1.0.11
Serial number	01626
Last update:	4 min(s) ago
AHU controlled by	MBSCHED
Supply air temp	18.2 °C
Supply air flow	554.0 l/s
Supply air duct pressure	266.0 Pa
Percentage of delta pressure for alarm - Supply filter	0.0 %
Extract air temp	21.3 °C
Extract air flow	553.0 l/s
Extract air duct pressure	224.0 Pa
Percentage of delta pressure for alarm - Extract filter	0.0 %
Outdoor air internal temp	10.0 °C

INSIDE Portal - alarm subscriptions

Alarm notifications can be sent via email for connected units

Home > Alarm subscriptions

My alarm subscriptions

Search for any keyword

DELETE SELECTED EDIT SELECTED + ADD ALARM SUBSCRIPTION

<input type="checkbox"/>	Product name	Notify at (severity)	Building name	City	Country	Product type	Organisation
<input type="checkbox"/>	Ki MS&et 1, Umeå	A B	Swegon Umeå	Umeå	Sweden	SuperWISE	Swegon
<input type="checkbox"/>	Åbyhøj GOLD	A B	Swegon Åbyhøj	Åbyhøj	Denmark	GOLD	Swegon Denmark
<input type="checkbox"/>	Zeta Sky HI R7 (R32)	A	Swegon Cantarana	Cantarana	Italy	BlueBox Chiller/Heatpump	Swegon
<input type="checkbox"/>	Titan Sky HI R0 HP	A	Swegon Cantarana	Cantarana	Italy	BlueBox Chiller/Heatpump	Swegon
<input type="checkbox"/>	GEYSER Sky R0 (R290)	A	Swegon Cantarana	Cantarana	Italy	BlueBox Chiller/Heatpump	Swegon
<input type="checkbox"/>	Epsilon Sky HI	A	Swegon Cantarana	Cantarana	Italy	BlueBox Epsilon SKY	Swegon
<input type="checkbox"/>	Basstallvägen 1 Örebro	A B I	Swegon Örebro	Örebro	Sweden	SuperWISE	Swegon
<input type="checkbox"/>	SWEGON BUREAU	A B I	Swegon France Lyon	Lyon	France	SuperWISE	Swegon
<input type="checkbox"/>	Zeta Rev	A	Swegon Cantarana	Cantarana	Italy	BlueBox Chiller/Heatpump	Swegon
<input type="checkbox"/>	TA/FA 73	A B I	Swegon Kårum	Kårum	Sweden	GOLD	Swegon
<input type="checkbox"/>	OPEN SPACE	A	Swegon Cantarana	Cantarana	Italy	GOLD	Swegon

Alarm subscriptions – how to?

Select alarms based on product, building, city and other parameters

The screenshot displays the 'Add alarm subscriptions' interface. On the left, there is a sidebar with 'My alarm subscriptions' and a search bar. The main area shows a table of subscriptions with columns for Product name, Notify at (severity), Building name, City, Country, Product type, and Organisation. Each row includes a set of checkboxes for severity levels (A, B, C, D, E, F, G, H, I, J, K, L, M, N, O, P, Q, R, S, T, U, V, W, X, Y, Z).

Product name	Notify at (severity)	Building name	City	Country	Product type	Organisation
Boställsvägen 1 Örebro	<input type="checkbox"/> A <input type="checkbox"/> B <input type="checkbox"/> C <input type="checkbox"/> D <input type="checkbox"/> E <input type="checkbox"/> F <input type="checkbox"/> G <input type="checkbox"/> H <input type="checkbox"/> I <input type="checkbox"/> J <input type="checkbox"/> K <input type="checkbox"/> L <input type="checkbox"/> M <input type="checkbox"/> N <input type="checkbox"/> O <input type="checkbox"/> P <input type="checkbox"/> Q <input type="checkbox"/> R <input type="checkbox"/> S <input type="checkbox"/> T <input type="checkbox"/> U <input type="checkbox"/> V <input type="checkbox"/> W <input type="checkbox"/> X <input type="checkbox"/> Y <input type="checkbox"/> Z	Swegon Örebro	Örebro	Sweden	SuperWISE	Swegon
SWEGON BUREAU	<input type="checkbox"/> A <input type="checkbox"/> B <input type="checkbox"/> C <input type="checkbox"/> D <input type="checkbox"/> E <input type="checkbox"/> F <input type="checkbox"/> G <input type="checkbox"/> H <input type="checkbox"/> I <input type="checkbox"/> J <input type="checkbox"/> K <input type="checkbox"/> L <input type="checkbox"/> M <input type="checkbox"/> N <input type="checkbox"/> O <input type="checkbox"/> P <input type="checkbox"/> Q <input type="checkbox"/> R <input type="checkbox"/> S <input type="checkbox"/> T <input type="checkbox"/> U <input type="checkbox"/> V <input type="checkbox"/> W <input type="checkbox"/> X <input type="checkbox"/> Y <input type="checkbox"/> Z	Swegon France Lyon	Lyon	France	SuperWISE	Swegon
TA/FA 73	<input type="checkbox"/> A <input type="checkbox"/> B <input type="checkbox"/> C <input type="checkbox"/> D <input type="checkbox"/> E <input type="checkbox"/> F <input type="checkbox"/> G <input type="checkbox"/> H <input type="checkbox"/> I <input type="checkbox"/> J <input type="checkbox"/> K <input type="checkbox"/> L <input type="checkbox"/> M <input type="checkbox"/> N <input type="checkbox"/> O <input type="checkbox"/> P <input type="checkbox"/> Q <input type="checkbox"/> R <input type="checkbox"/> S <input type="checkbox"/> T <input type="checkbox"/> U <input type="checkbox"/> V <input type="checkbox"/> W <input type="checkbox"/> X <input type="checkbox"/> Y <input type="checkbox"/> Z	Swegon Krånium	Krånium	Sweden	GOLD	Swegon
Åbyhej GOLD	<input type="checkbox"/> A <input type="checkbox"/> B <input type="checkbox"/> C <input type="checkbox"/> D <input type="checkbox"/> E <input type="checkbox"/> F <input type="checkbox"/> G <input type="checkbox"/> H <input type="checkbox"/> I <input type="checkbox"/> J <input type="checkbox"/> K <input type="checkbox"/> L <input type="checkbox"/> M <input type="checkbox"/> N <input type="checkbox"/> O <input type="checkbox"/> P <input type="checkbox"/> Q <input type="checkbox"/> R <input type="checkbox"/> S <input type="checkbox"/> T <input type="checkbox"/> U <input type="checkbox"/> V <input type="checkbox"/> W <input type="checkbox"/> X <input type="checkbox"/> Y <input type="checkbox"/> Z	Swegon Åbyhej	Åbyhej	Denmark	GOLD	Swegon Denmark
Kv Målet 1, Umeå	<input type="checkbox"/> A <input type="checkbox"/> B <input type="checkbox"/> C <input type="checkbox"/> D <input type="checkbox"/> E <input type="checkbox"/> F <input type="checkbox"/> G <input type="checkbox"/> H <input type="checkbox"/> I <input type="checkbox"/> J <input type="checkbox"/> K <input type="checkbox"/> L <input type="checkbox"/> M <input type="checkbox"/> N <input type="checkbox"/> O <input type="checkbox"/> P <input type="checkbox"/> Q <input type="checkbox"/> R <input type="checkbox"/> S <input type="checkbox"/> T <input type="checkbox"/> U <input type="checkbox"/> V <input type="checkbox"/> W <input type="checkbox"/> X <input type="checkbox"/> Y <input type="checkbox"/> Z	Swegon Umeå	Umeå	Sweden	SuperWISE	Swegon
TA 12	<input type="checkbox"/> A <input type="checkbox"/> B <input type="checkbox"/> C <input type="checkbox"/> D <input type="checkbox"/> E <input type="checkbox"/> F <input type="checkbox"/> G <input type="checkbox"/> H <input type="checkbox"/> I <input type="checkbox"/> J <input type="checkbox"/> K <input type="checkbox"/> L <input type="checkbox"/> M <input type="checkbox"/> N <input type="checkbox"/> O <input type="checkbox"/> P <input type="checkbox"/> Q <input type="checkbox"/> R <input type="checkbox"/> S <input type="checkbox"/> T <input type="checkbox"/> U <input type="checkbox"/> V <input type="checkbox"/> W <input type="checkbox"/> X <input type="checkbox"/> Y <input type="checkbox"/> Z	Swegon Gothenburg	Gothenburg	Sweden	GOLD	Swegon
GOLD 2005646491	<input type="checkbox"/> A <input type="checkbox"/> B <input type="checkbox"/> C <input type="checkbox"/> D <input type="checkbox"/> E <input type="checkbox"/> F <input type="checkbox"/> G <input type="checkbox"/> H <input type="checkbox"/> I <input type="checkbox"/> J <input type="checkbox"/> K <input type="checkbox"/> L <input type="checkbox"/> M <input type="checkbox"/> N <input type="checkbox"/> O <input type="checkbox"/> P <input type="checkbox"/> Q <input type="checkbox"/> R <input type="checkbox"/> S <input type="checkbox"/> T <input type="checkbox"/> U <input type="checkbox"/> V <input type="checkbox"/> W <input type="checkbox"/> X <input type="checkbox"/> Y <input type="checkbox"/> Z	Swegon Sundsvall	Sundsvall	Sweden	GOLD	Swegon
Swegon - Brandby	<input type="checkbox"/> A <input type="checkbox"/> B <input type="checkbox"/> C <input type="checkbox"/> D <input type="checkbox"/> E <input type="checkbox"/> F <input type="checkbox"/> G <input type="checkbox"/> H <input type="checkbox"/> I <input type="checkbox"/> J <input type="checkbox"/> K <input type="checkbox"/> L <input type="checkbox"/> M <input type="checkbox"/> N <input type="checkbox"/> O <input type="checkbox"/> P <input type="checkbox"/> Q <input type="checkbox"/> R <input type="checkbox"/> S <input type="checkbox"/> T <input type="checkbox"/> U <input type="checkbox"/> V <input type="checkbox"/> W <input type="checkbox"/> X <input type="checkbox"/> Y <input type="checkbox"/> Z	Swegon Brandby	Brandby	Denmark	SuperWISE	Swegon Denmark
Swegon Malmö	<input type="checkbox"/> A <input type="checkbox"/> B <input type="checkbox"/> C <input type="checkbox"/> D <input type="checkbox"/> E <input type="checkbox"/> F <input type="checkbox"/> G <input type="checkbox"/> H <input type="checkbox"/> I <input type="checkbox"/> J <input type="checkbox"/> K <input type="checkbox"/> L <input type="checkbox"/> M <input type="checkbox"/> N <input type="checkbox"/> O <input type="checkbox"/> P <input type="checkbox"/> Q <input type="checkbox"/> R <input type="checkbox"/> S <input type="checkbox"/> T <input type="checkbox"/> U <input type="checkbox"/> V <input type="checkbox"/> W <input type="checkbox"/> X <input type="checkbox"/> Y <input type="checkbox"/> Z	Swegon Malmö	Malmö	Sweden	SuperWISE	Swegon
Swegon Göteborg	<input type="checkbox"/> A <input type="checkbox"/> B <input type="checkbox"/> C <input type="checkbox"/> D <input type="checkbox"/> E <input type="checkbox"/> F <input type="checkbox"/> G <input type="checkbox"/> H <input type="checkbox"/> I <input type="checkbox"/> J <input type="checkbox"/> K <input type="checkbox"/> L <input type="checkbox"/> M <input type="checkbox"/> N <input type="checkbox"/> O <input type="checkbox"/> P <input type="checkbox"/> Q <input type="checkbox"/> R <input type="checkbox"/> S <input type="checkbox"/> T <input type="checkbox"/> U <input type="checkbox"/> V <input type="checkbox"/> W <input type="checkbox"/> X <input type="checkbox"/> Y <input type="checkbox"/> Z	Swegon Gothenburg	Gothenburg	Sweden	SuperWISE	Swegon
LB03 Luleå	<input type="checkbox"/> A <input type="checkbox"/> B <input type="checkbox"/> C <input type="checkbox"/> D <input type="checkbox"/> E <input type="checkbox"/> F <input type="checkbox"/> G <input type="checkbox"/> H <input type="checkbox"/> I <input type="checkbox"/> J <input type="checkbox"/> K <input type="checkbox"/> L <input type="checkbox"/> M <input type="checkbox"/> N <input type="checkbox"/> O <input type="checkbox"/> P <input type="checkbox"/> Q <input type="checkbox"/> R <input type="checkbox"/> S <input type="checkbox"/> T <input type="checkbox"/> U <input type="checkbox"/> V <input type="checkbox"/> W <input type="checkbox"/> X <input type="checkbox"/> Y <input type="checkbox"/> Z	Swegon Luleå	Luleå	Sweden	GOLD	Swegon
GOLD Umeå	<input type="checkbox"/> A <input type="checkbox"/> B <input type="checkbox"/> C <input type="checkbox"/> D <input type="checkbox"/> E <input type="checkbox"/> F <input type="checkbox"/> G <input type="checkbox"/> H <input type="checkbox"/> I <input type="checkbox"/> J <input type="checkbox"/> K <input type="checkbox"/> L <input type="checkbox"/> M <input type="checkbox"/> N <input type="checkbox"/> O <input type="checkbox"/> P <input type="checkbox"/> Q <input type="checkbox"/> R <input type="checkbox"/> S <input type="checkbox"/> T <input type="checkbox"/> U <input type="checkbox"/> V <input type="checkbox"/> W <input type="checkbox"/> X <input type="checkbox"/> Y <input type="checkbox"/> Z	Swegon Umeå	Umeå	Sweden	GOLD	Swegon
Norrkänninga kontor	<input type="checkbox"/> A <input type="checkbox"/> B <input type="checkbox"/> C <input type="checkbox"/> D <input type="checkbox"/> E <input type="checkbox"/> F <input type="checkbox"/> G <input type="checkbox"/> H <input type="checkbox"/> I <input type="checkbox"/> J <input type="checkbox"/> K <input type="checkbox"/> L <input type="checkbox"/> M <input type="checkbox"/> N <input type="checkbox"/> O <input type="checkbox"/> P <input type="checkbox"/> Q <input type="checkbox"/> R <input type="checkbox"/> S <input type="checkbox"/> T <input type="checkbox"/> U <input type="checkbox"/> V <input type="checkbox"/> W <input type="checkbox"/> X <input type="checkbox"/> Y <input type="checkbox"/> Z	Swegon Norrkänninga	Norrkänninga	Sweden	SuperWISE	Swegon

INSIDE Portal – overview

Full overview of all buildings within organisation

- Building name
- Building location
- Number of products

Home > Buildings

Buildings

Search for building name

Name	City	Country	Number of products	Role
Properties Head office (Demo building)	Milan	Italy	5	Organisation Admin
Refurb Demo	Kvånum	Sweden	1	Building Admin
Umeå Demo	Umeå	Sweden	2	Building Admin

Rows per page: 100 1-3 of 3

DU

INSIDE Portal – overview

Full overview of Swegon products per building

- Location
- Software version
- Active alarms
- Connectivity status

The screenshot displays the Swegon INSIDE Portal interface. On the left, a map shows the location of Swegon Operations Belgium. The main content area features a 'Products' table with columns for Name, Product type, Building, Serial number, Software version, Active alarm, INSIDE Cloud, and INSIDE Connect. Below the table, there are sections for 'INSIDE Connect routers', 'Building administrators', 'Active alarms', and 'Settings'.

Home > Organisations > Swegon Belgium > Building: Swegon Operations Belgium

← GO BACK

Swegon Operations Belgium
Organisation: Swegon Belgium

Products

Search (name, serial number) + CLAIM PRODUCT

Name ↑	Product type ▾	Building	Serial number	Software version	Active alarm	INSIDE Cloud	INSIDE Connect
PROD OFFICES	GLOBAL (TAC7) PX LP	Swegon Operations Belgium	01626563	1.0.11			CONNECT 30 MIN <input type="button" value="v"/>
TOIT LABO	GLOBAL (TAC7) RX	Swegon Operations Belgium	01627626	1.0.11			CONNECT 30 MIN <input type="button" value="v"/>

Rows per page: 100 ▾ 1-2 of 2 < >

INSIDE Connect routers

Building administrators

Active alarms

Settings

INSIDE Portal - login

<https://inside.swegon.com/>

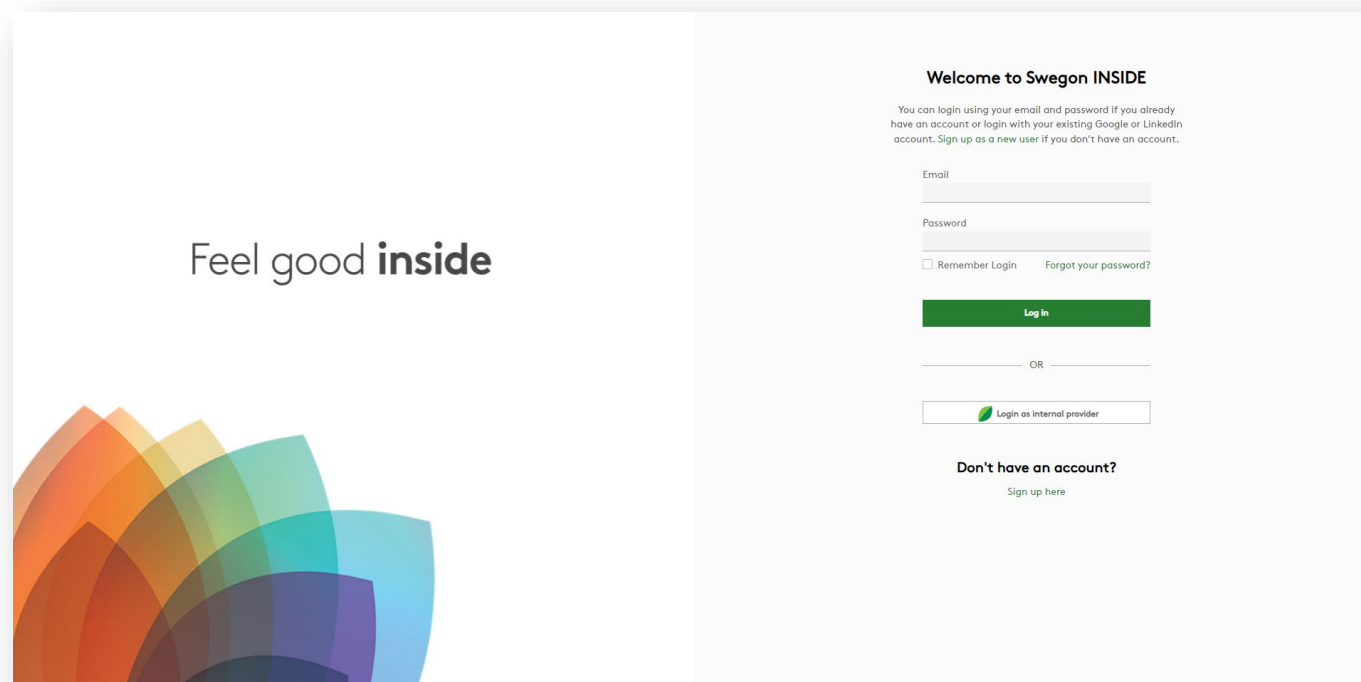

Way to monitor products

GLOBAL, ESENSA & SERENITY

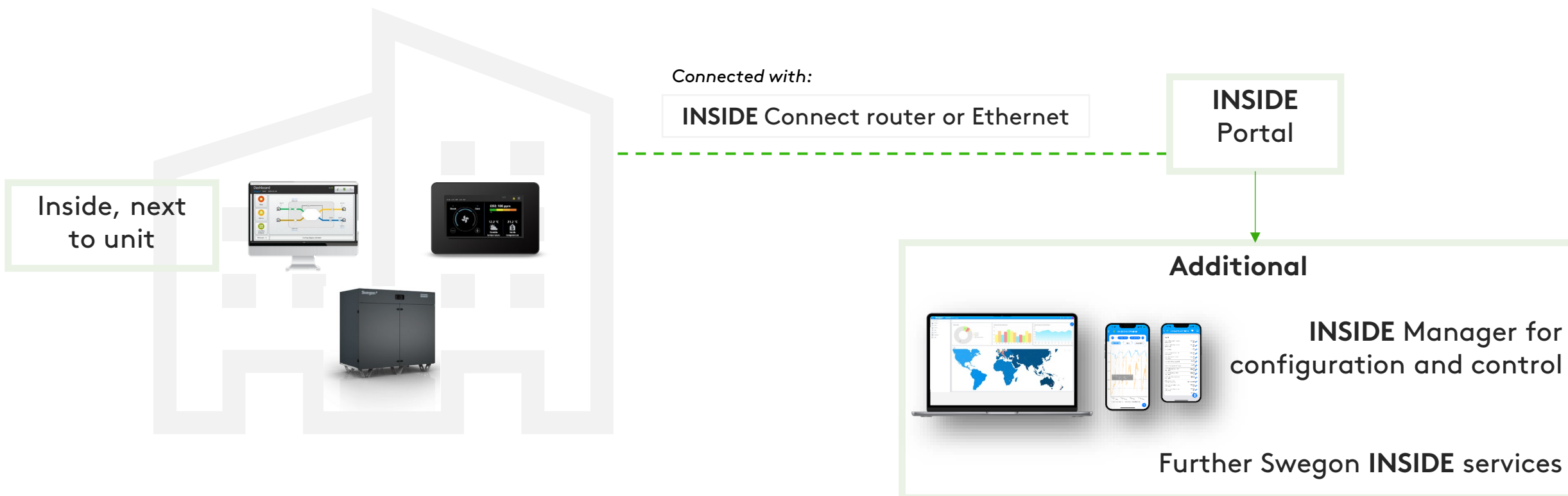

Digital services

All systems & sensor data

INSIDE Integration
Enriching customers' already existing building-related systems w. data from Swegon products.

Indoor climate data

INSIDE Analytics & Visualiser
Encompassing service for IEQ, reporting, energy monitoring and occupant satisfaction.

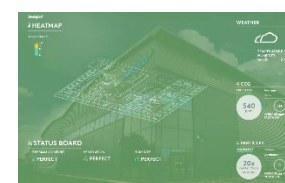
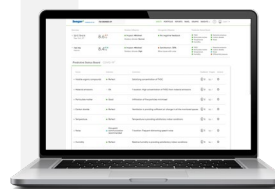

Unit performance data

INSIDE Portal and INSIDE Manager
Enables unit overview, active alarms, remote monitoring and control.

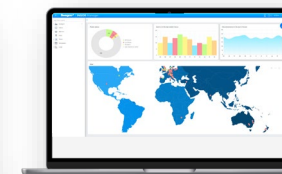



Feel good **inside**